



ALIEN CONQUEST

7067



1

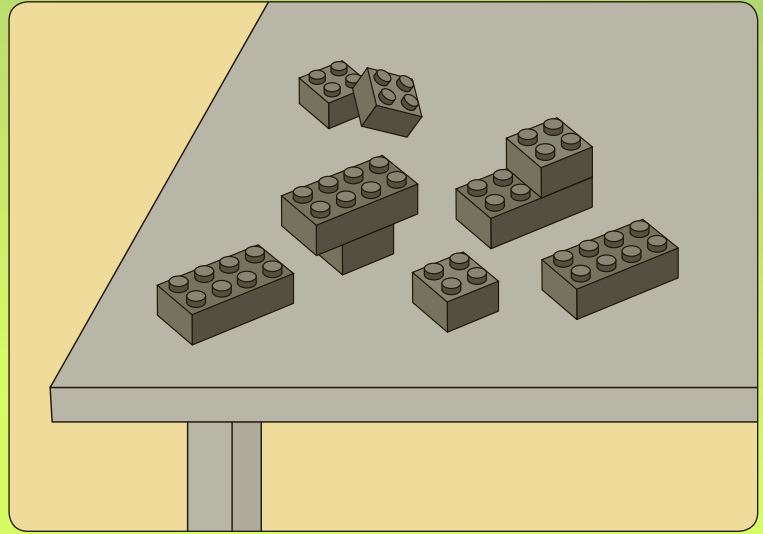
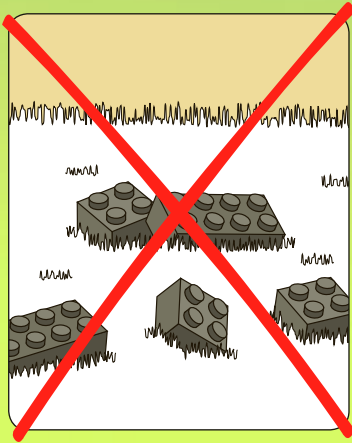

2



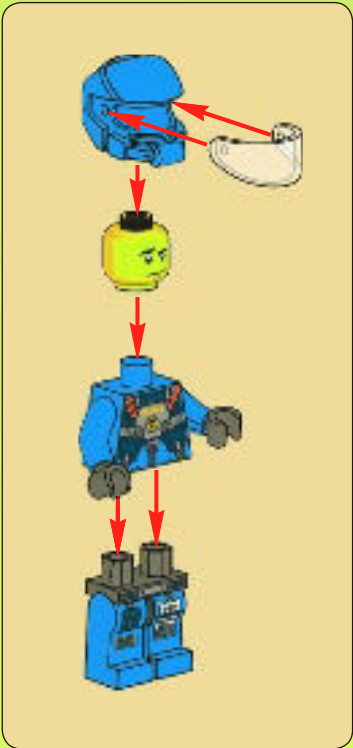
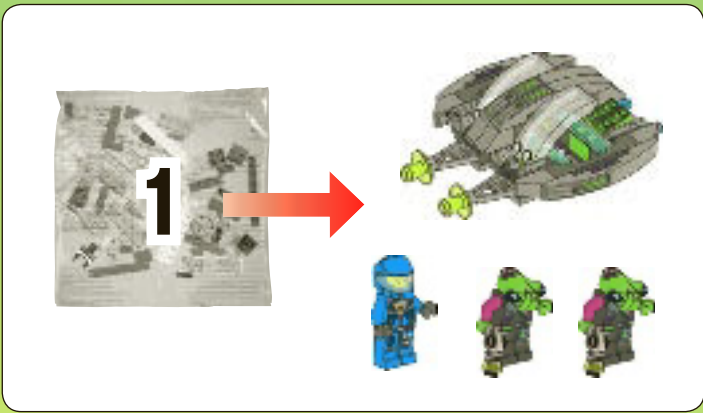



2x



1x

1



2x

2

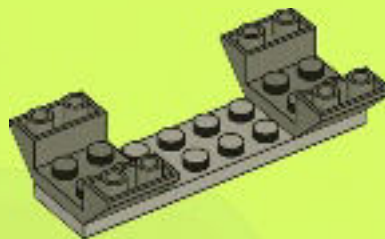

2x



4x

3

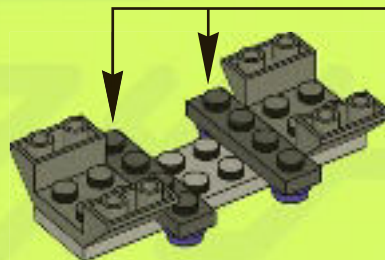

2x



4

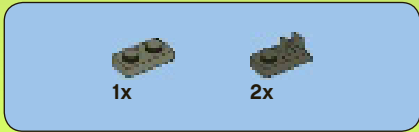
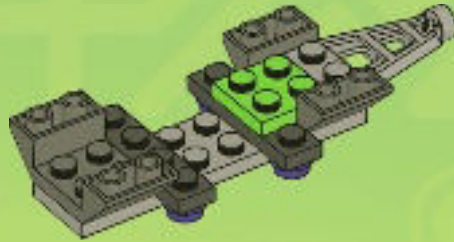

5

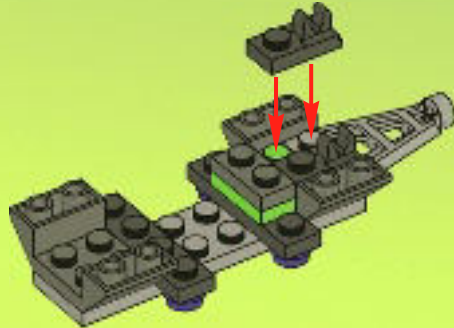

6

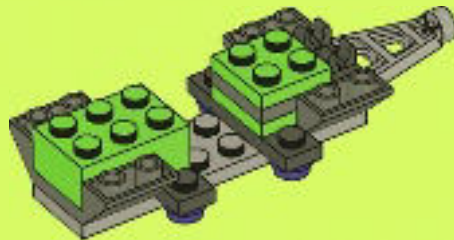



4x

7

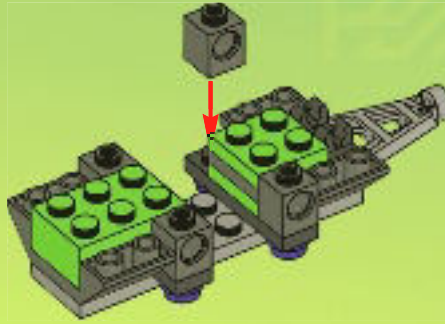

1x



1x



2x

8

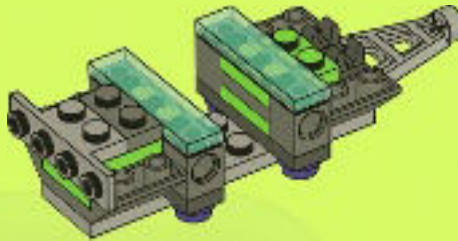

4x

9

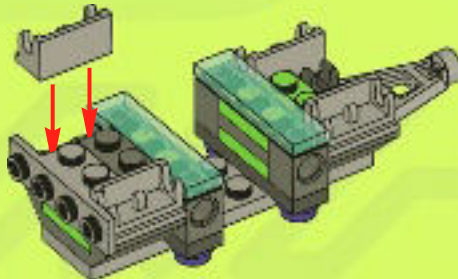



2x



2x

10

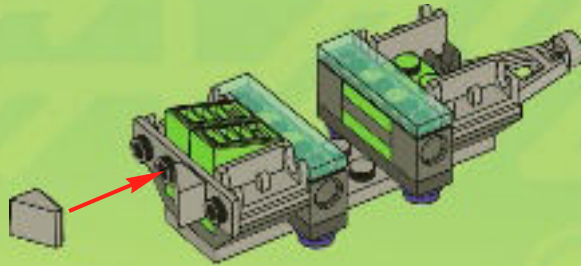

2x

11

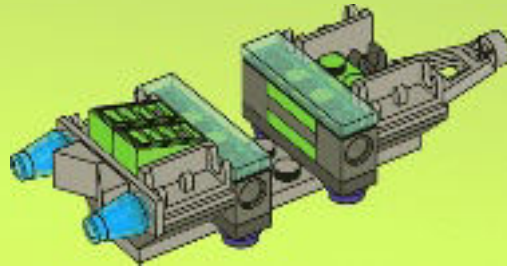

1x



1x

12

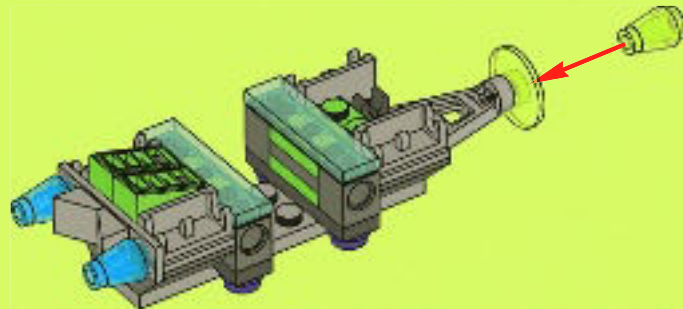



2x



4x



4x



4x



2x



2x



4x

13

1

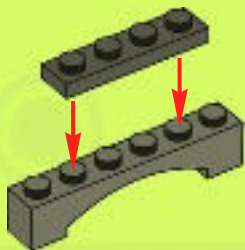

2



3

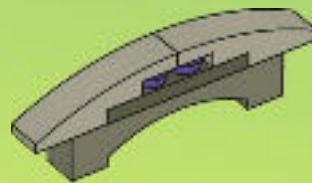

4

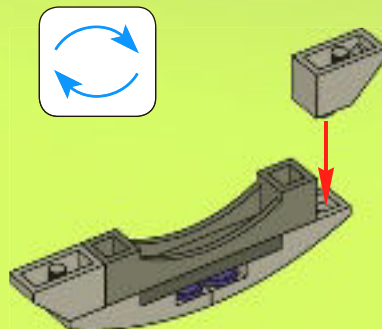

5

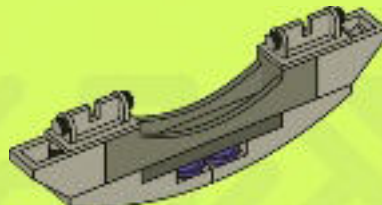

6

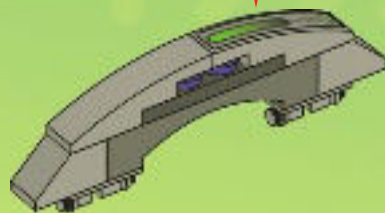

2x

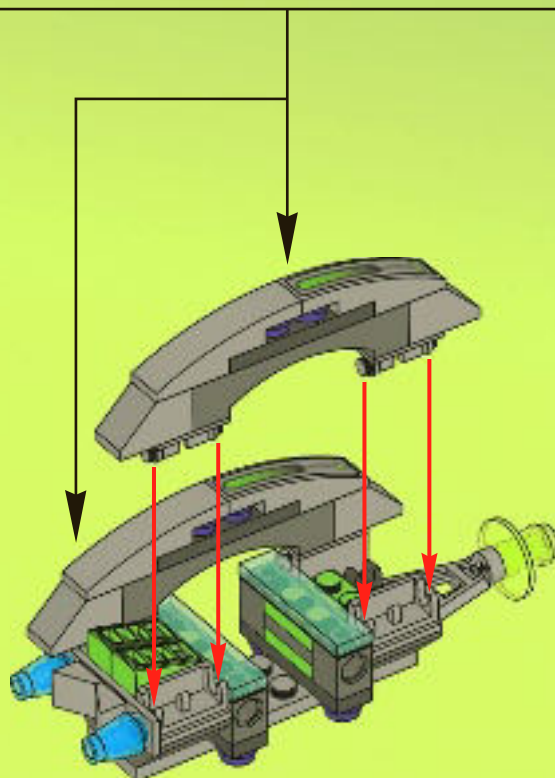



14

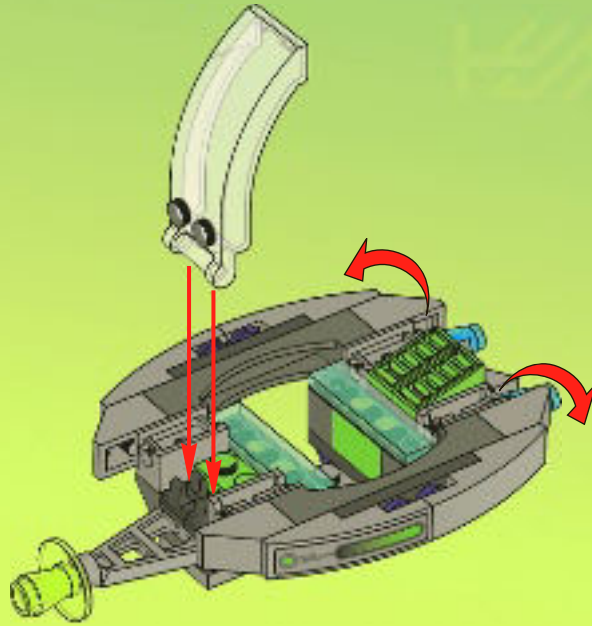

2x



15

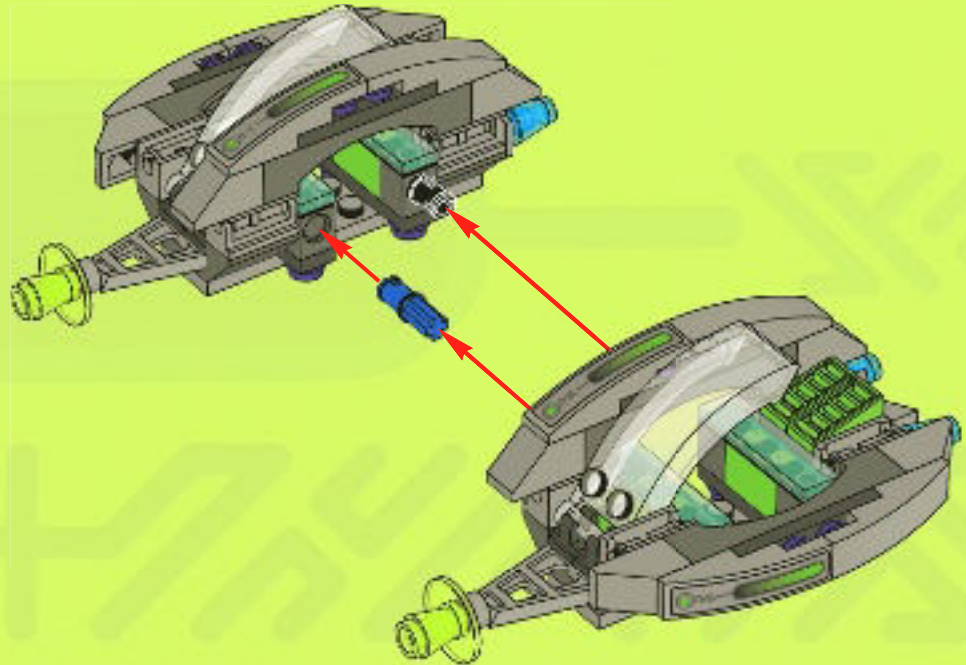

16

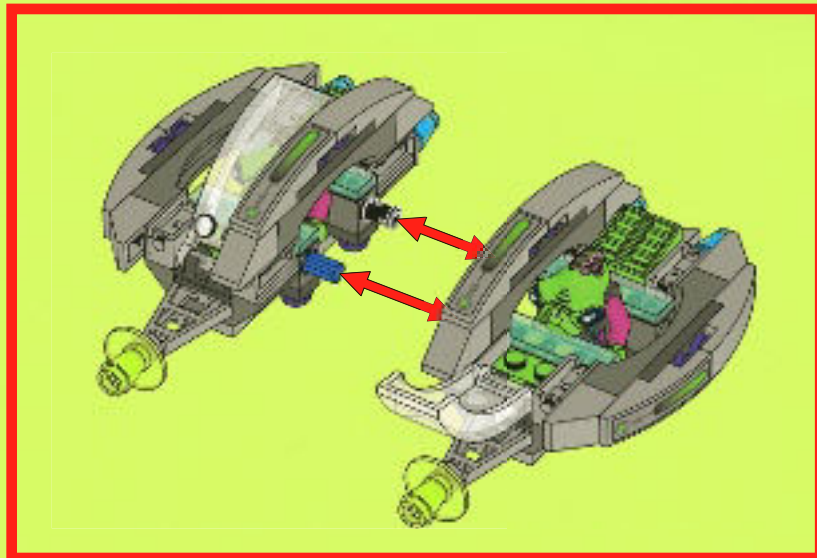
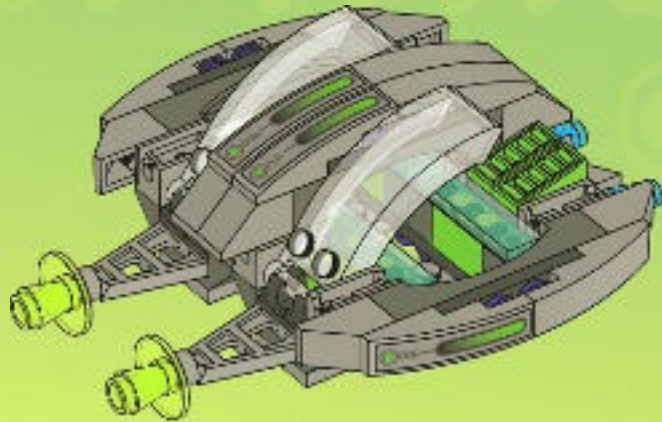

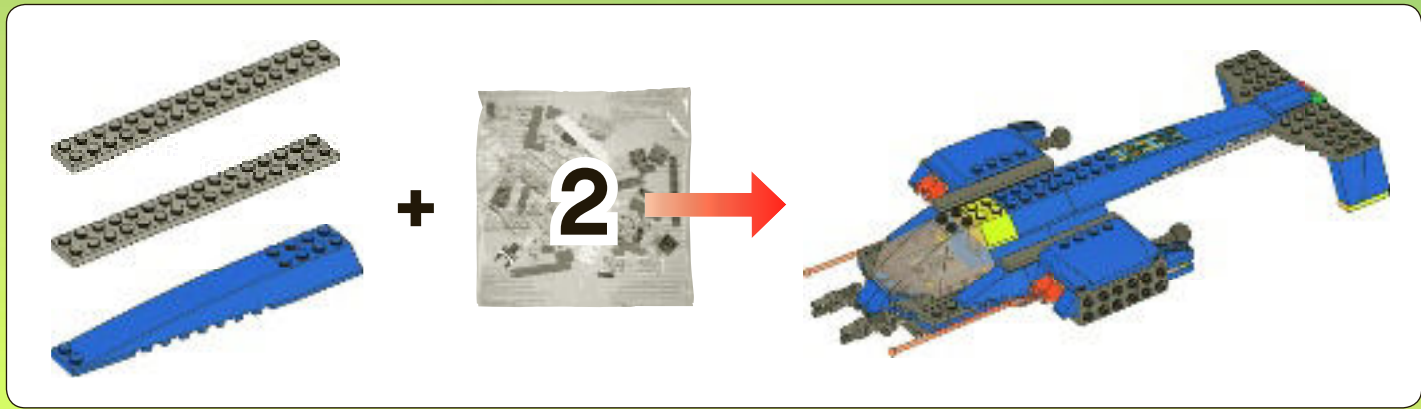

1

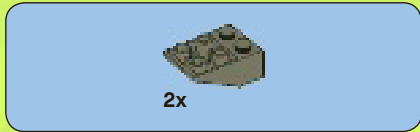

2

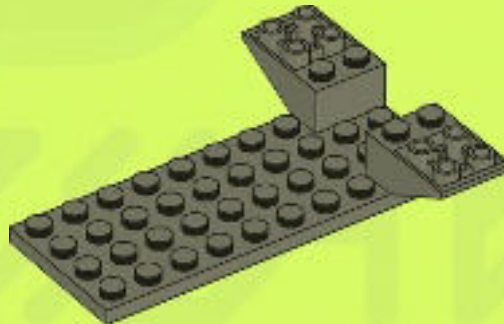



3

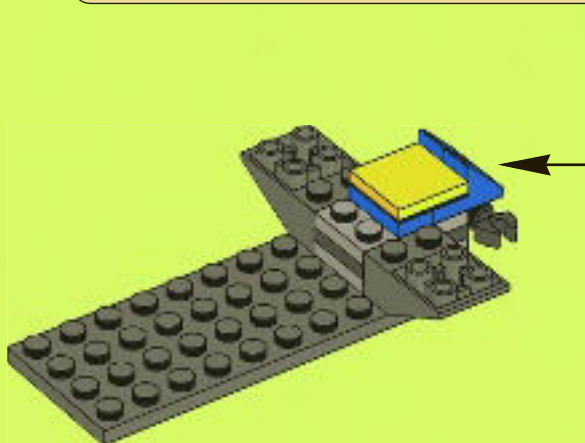
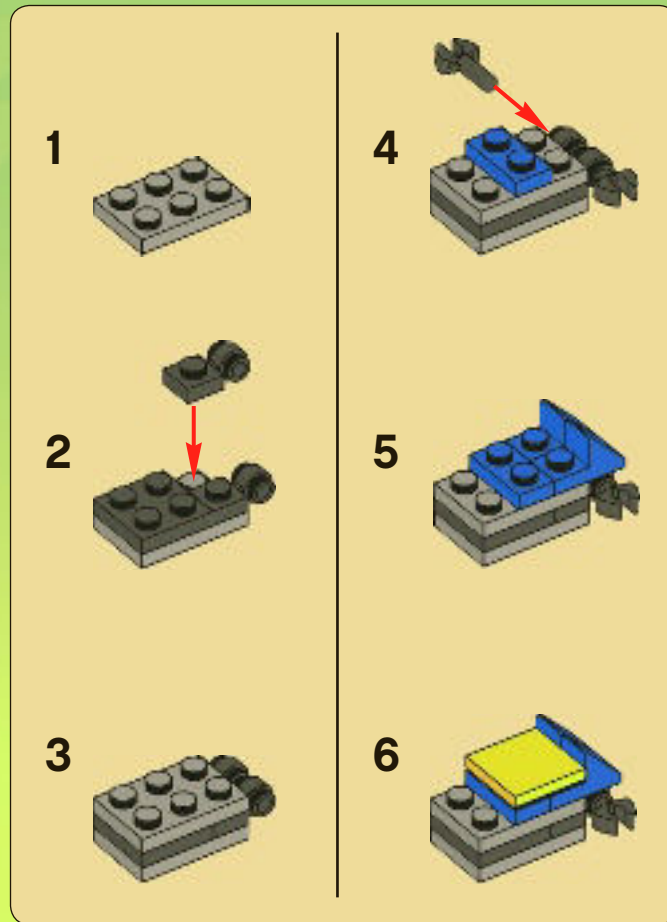



1x



1x

4

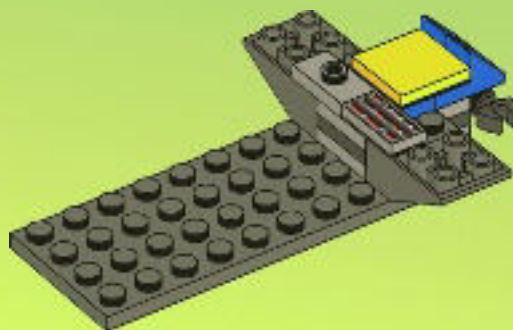

1x



1x

5

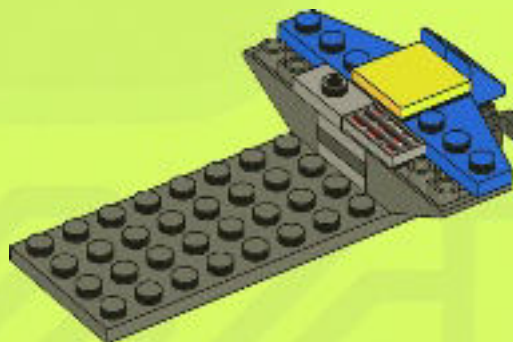



2x

8

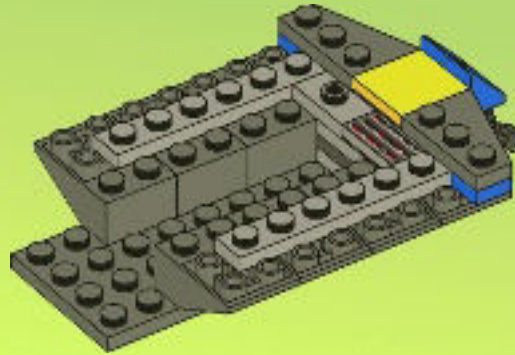

2x

9

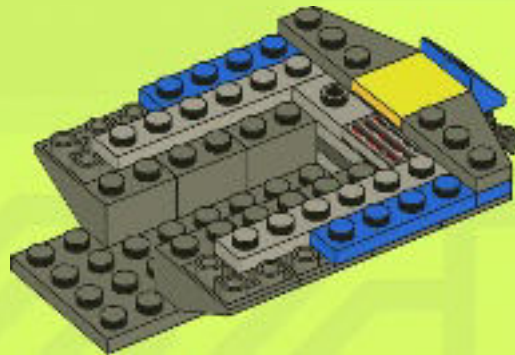

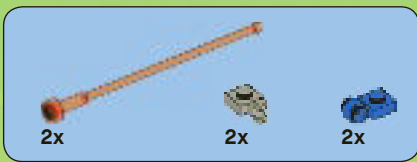

10

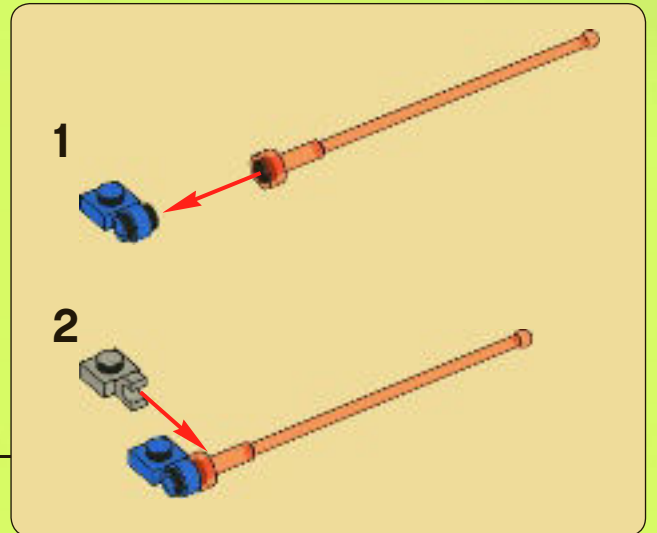
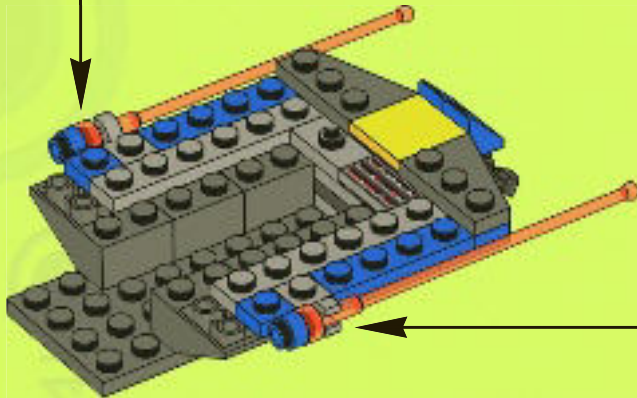
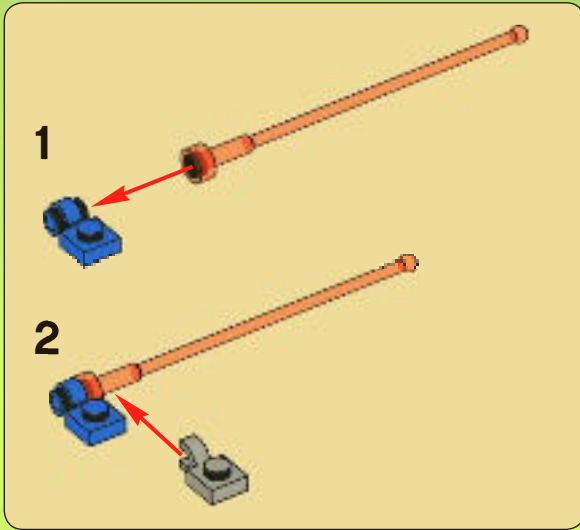



2x

11

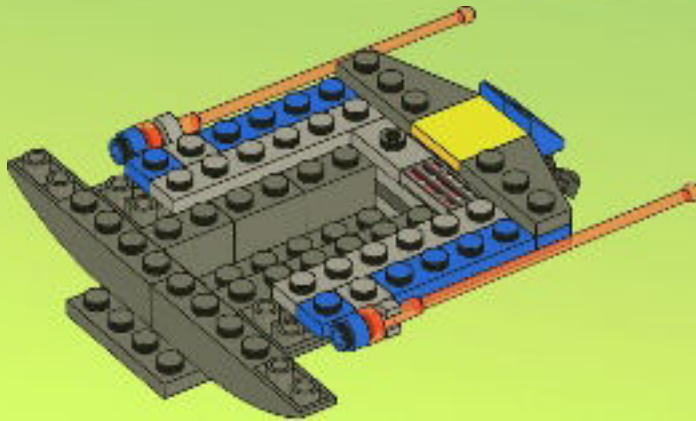

2x



1x

12

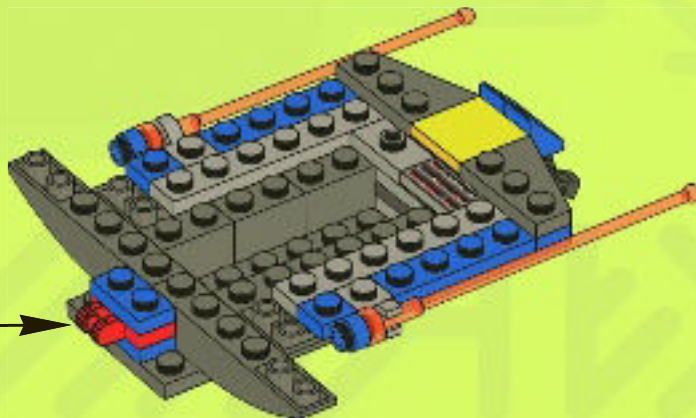
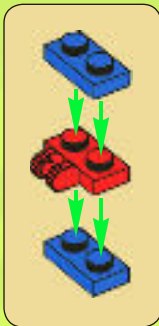



2x



2x

13

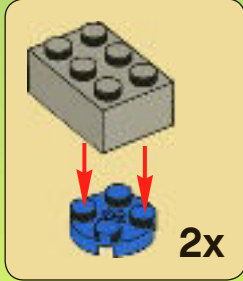

2x

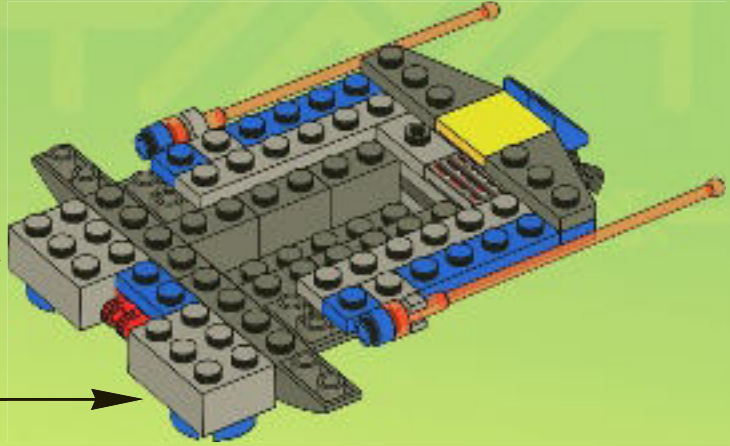

3x

14

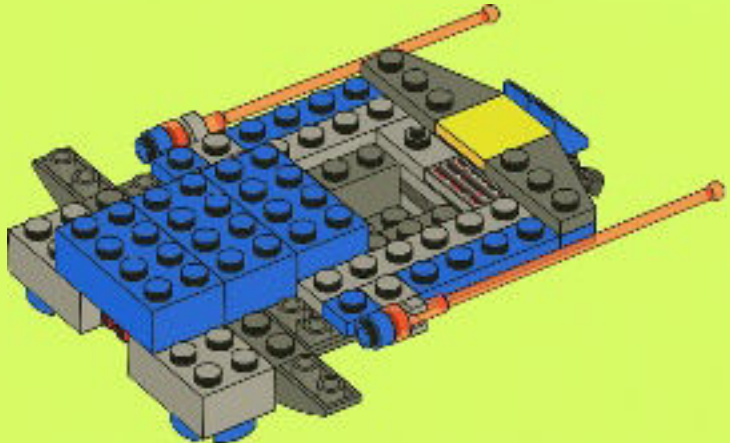

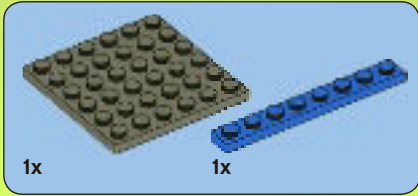

1



2





3

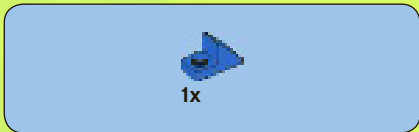

4

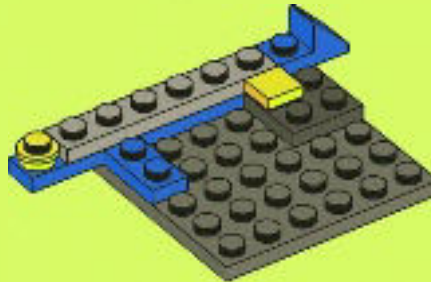

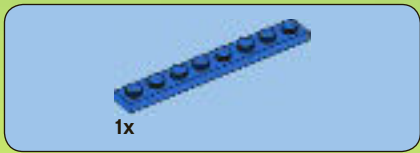

5

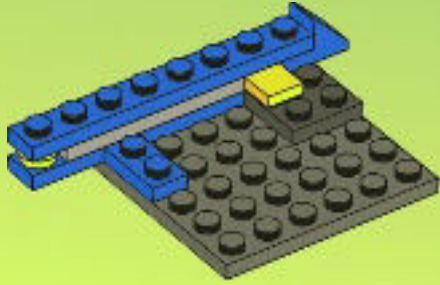

6

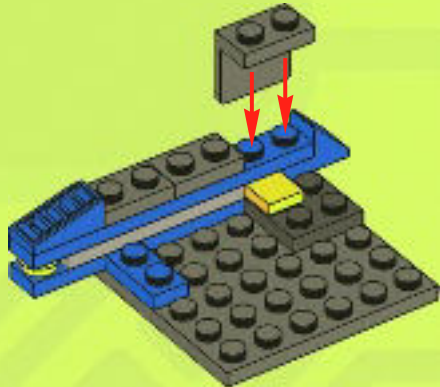

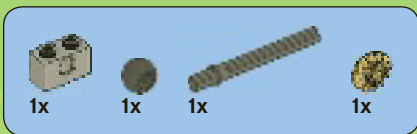

7

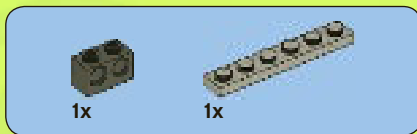
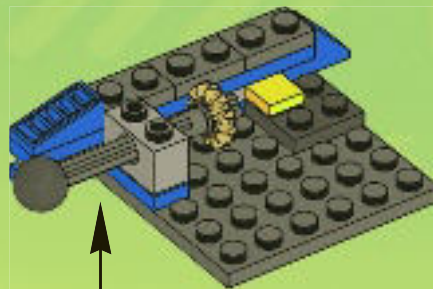
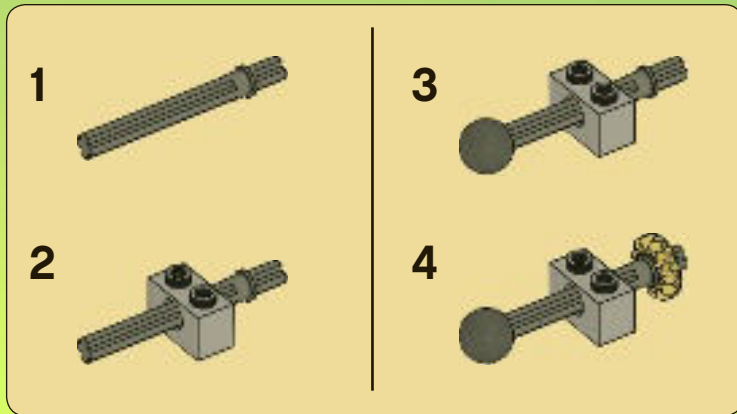

8

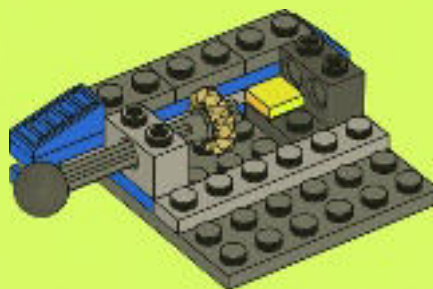



9

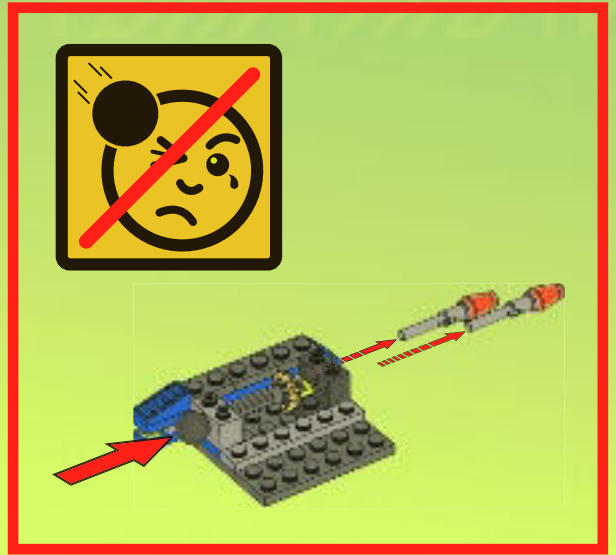
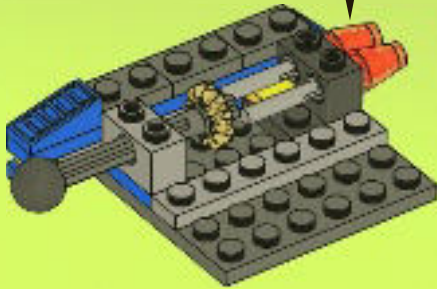

15

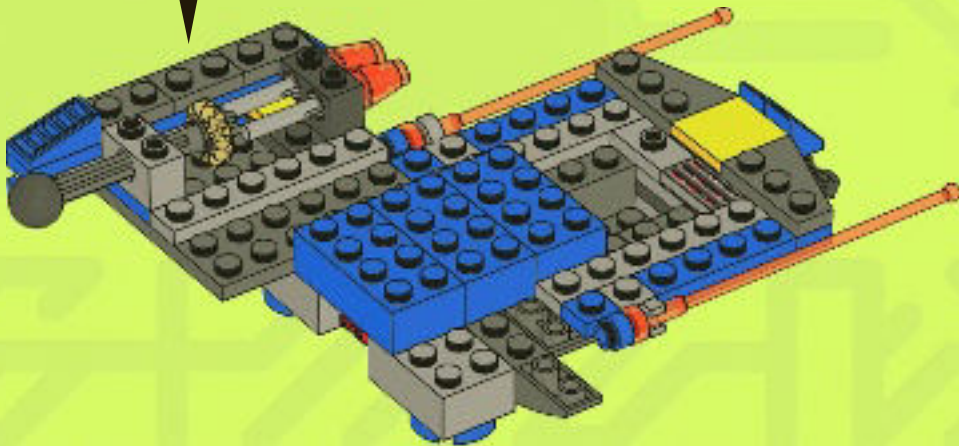

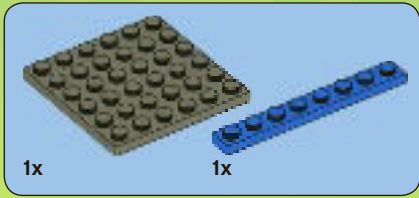

1

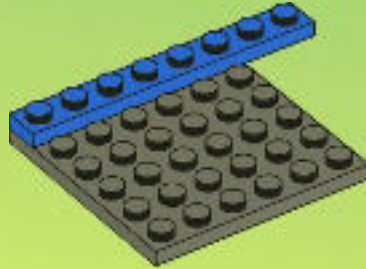

2

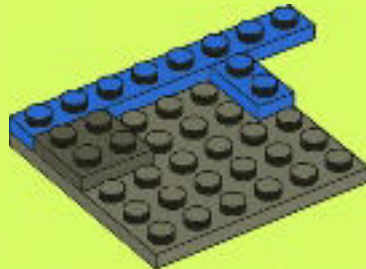



3



4

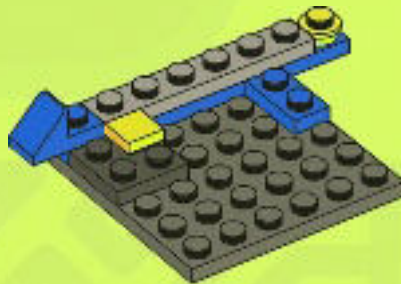

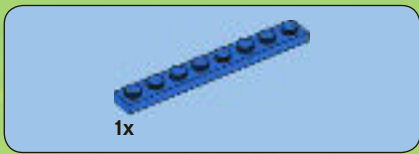

5



6

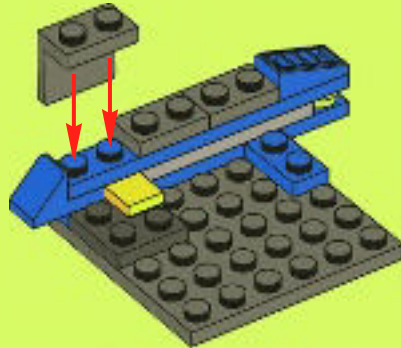

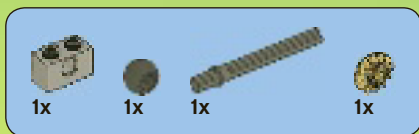

7

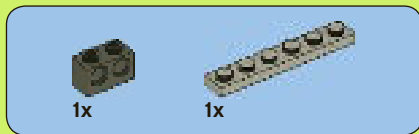
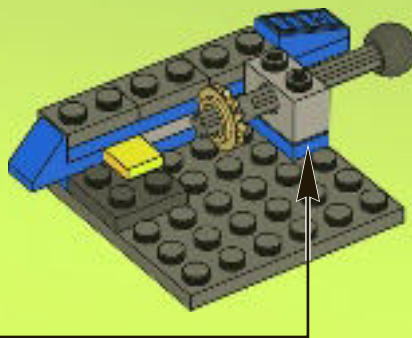
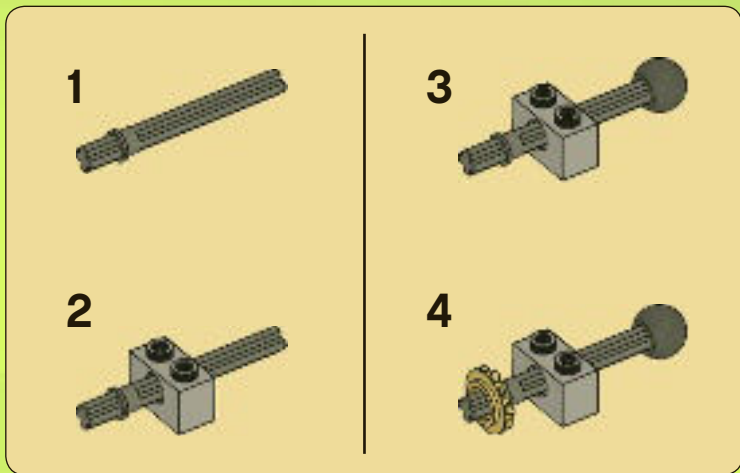

8

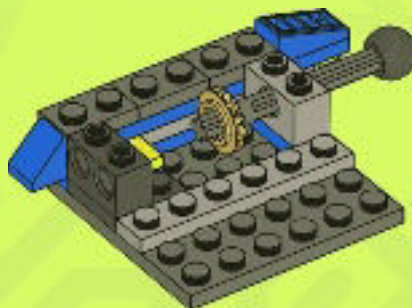

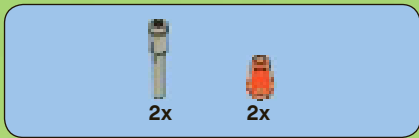

9

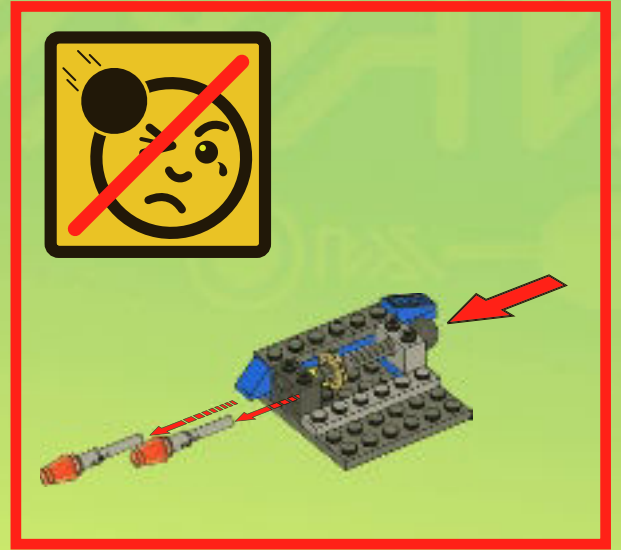
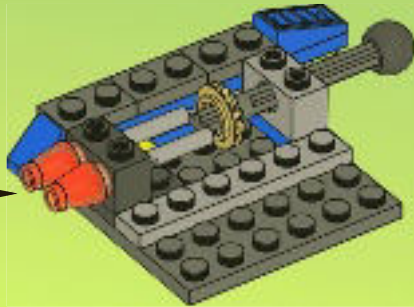
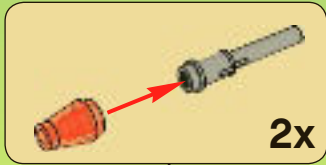

16

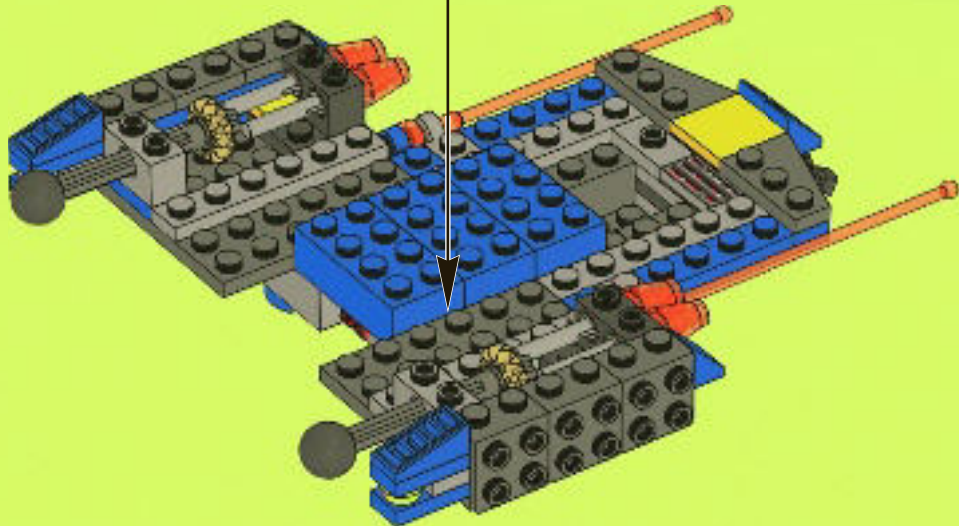

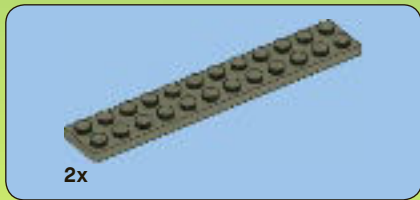

17

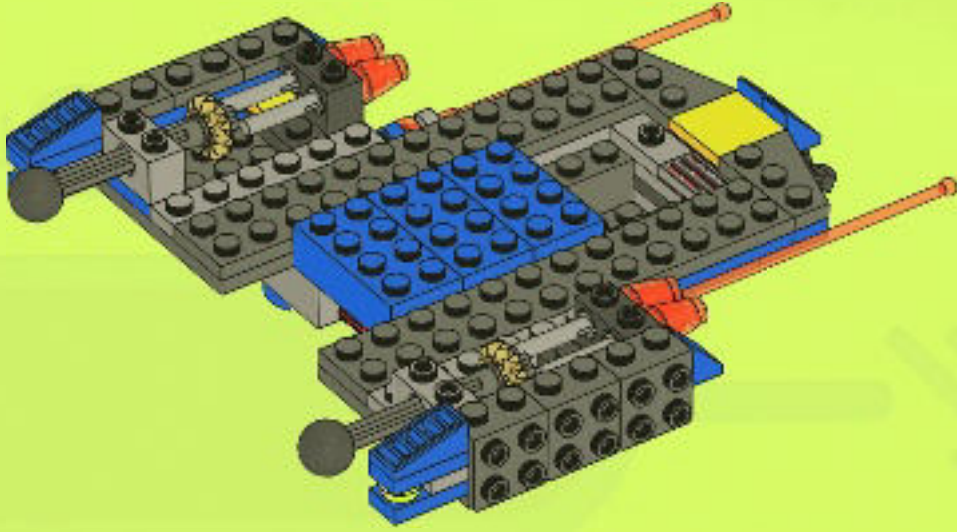



18

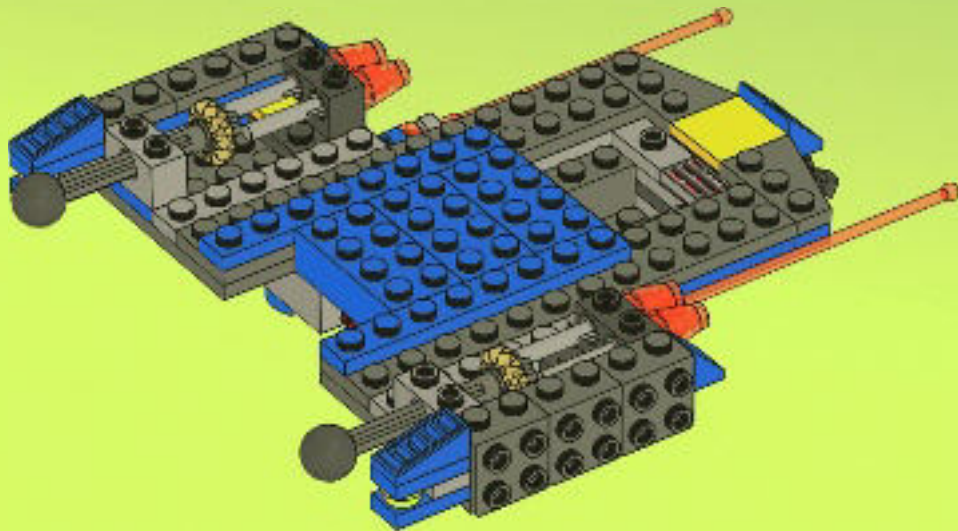



19

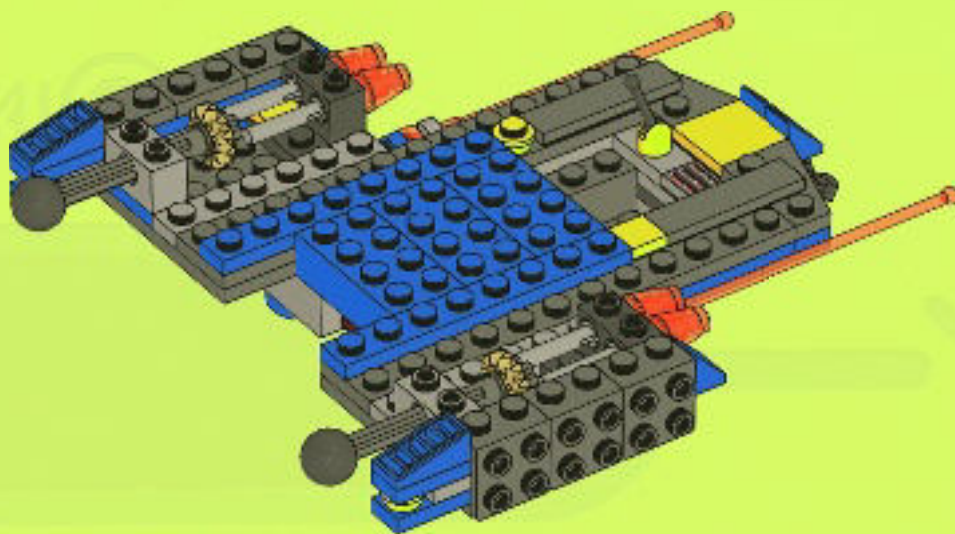



20

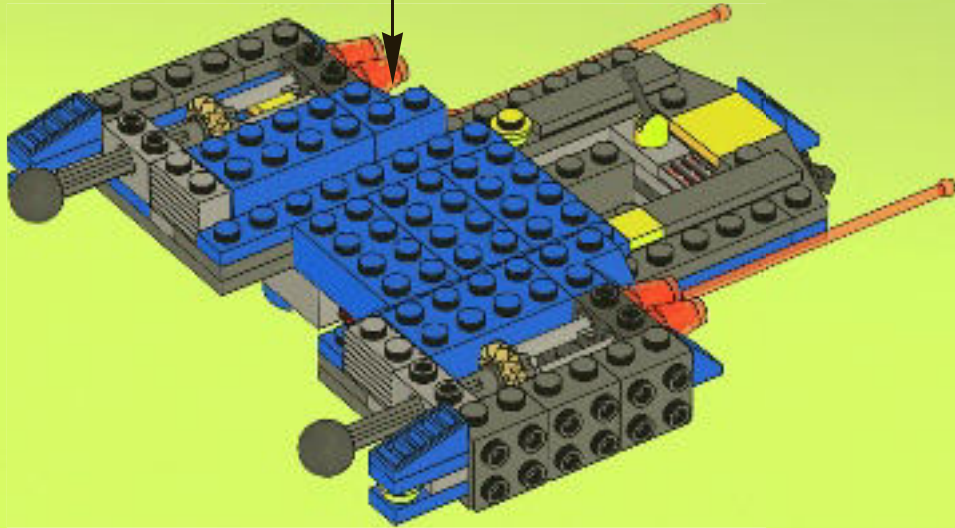
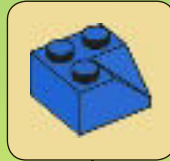

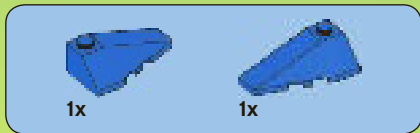

21

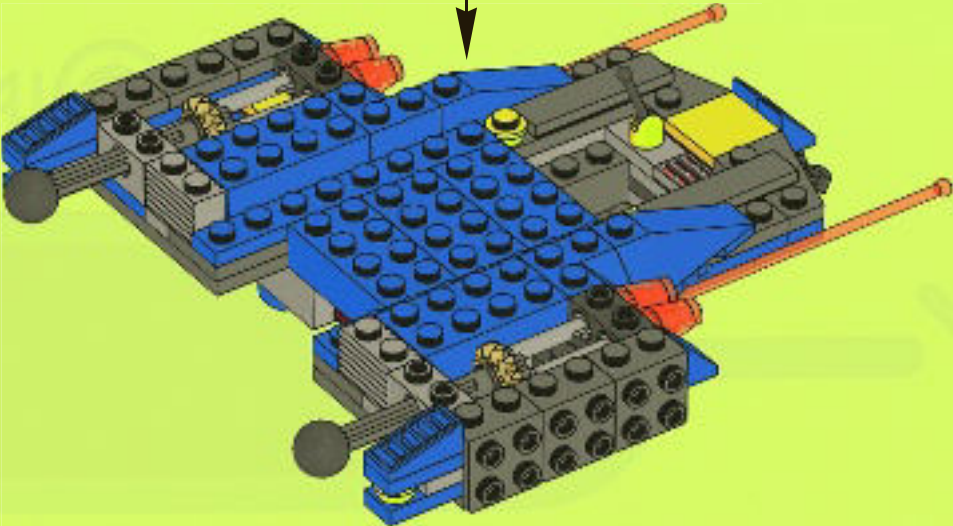



4x



1x

22

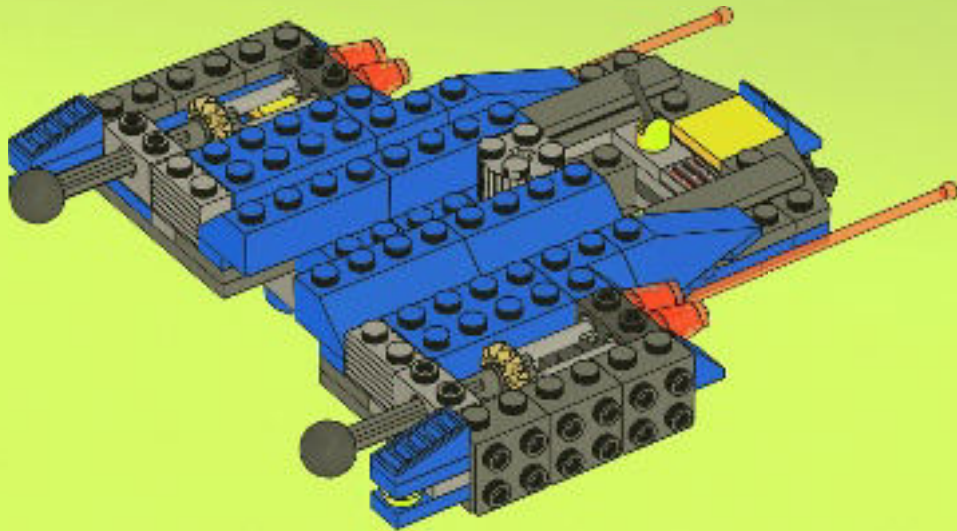



23

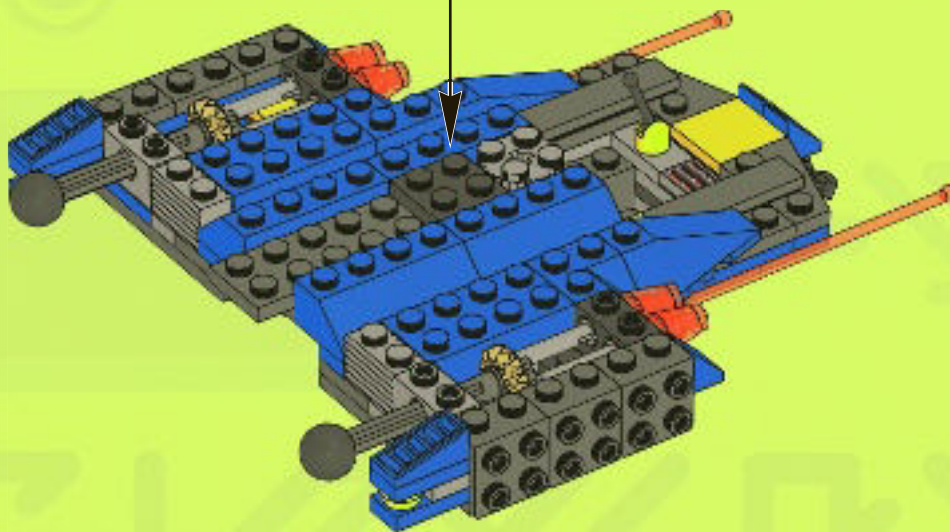
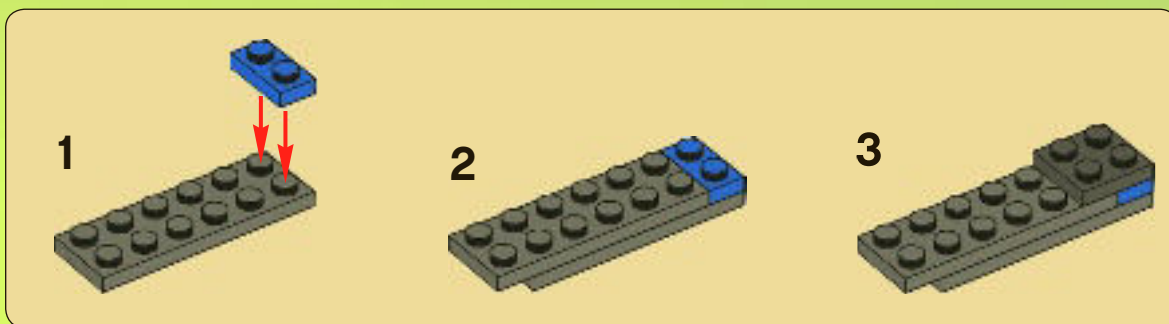

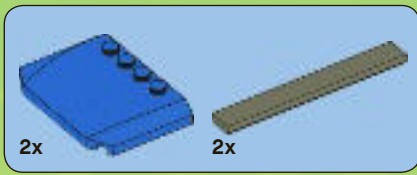

24

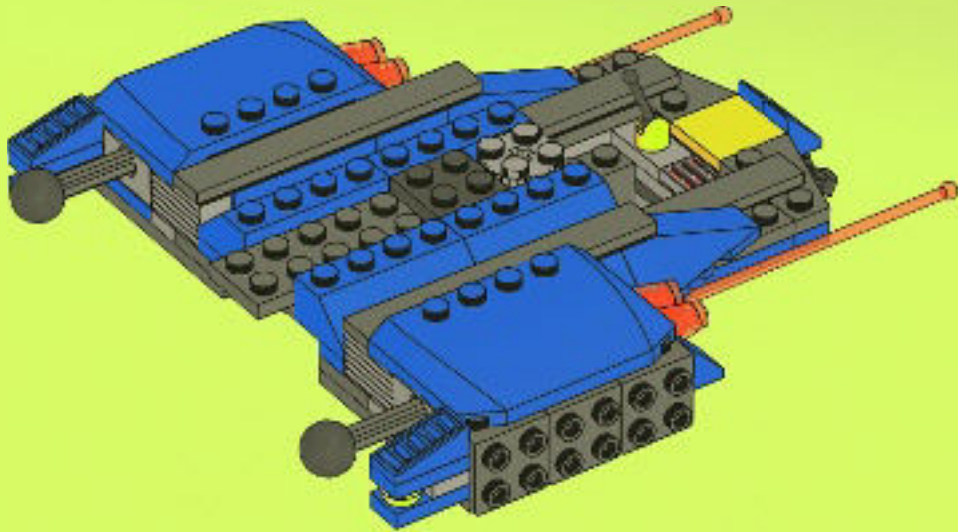

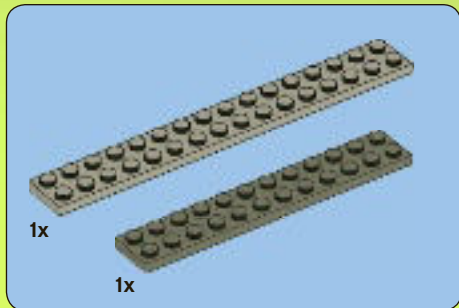

1

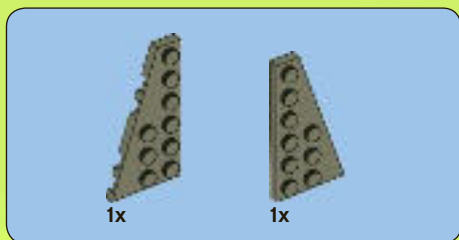
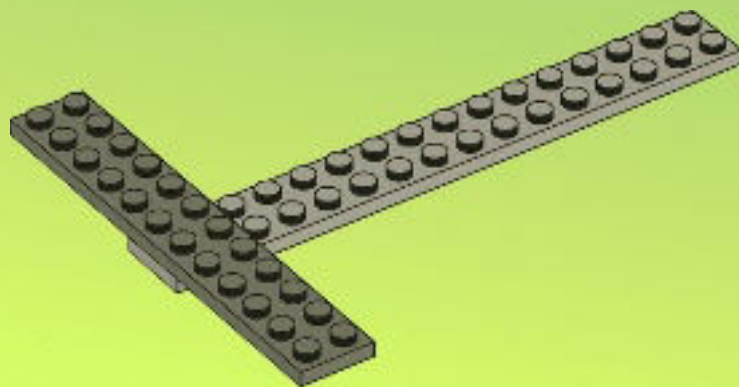

2

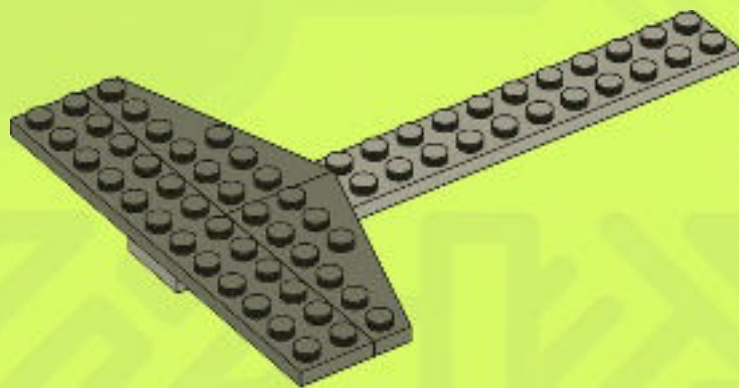



3

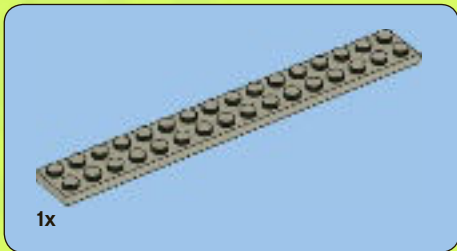
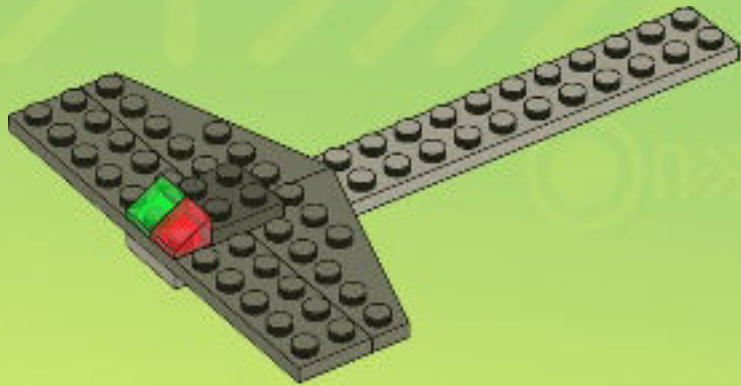

4

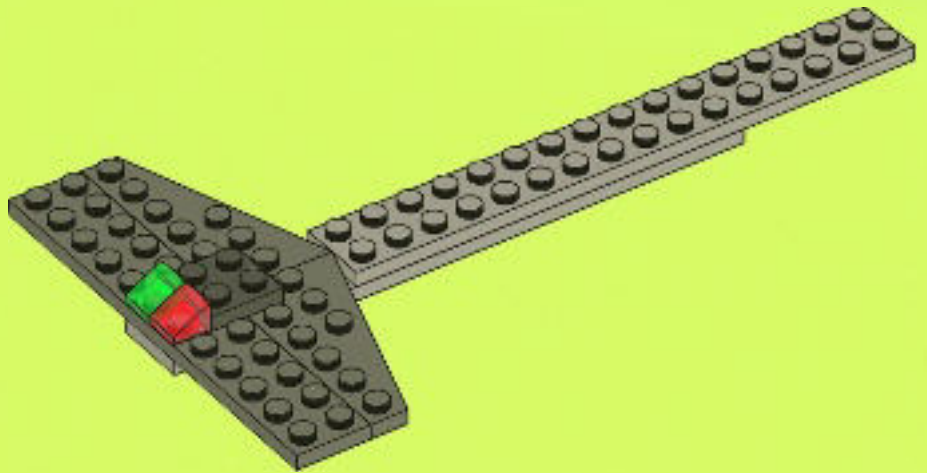

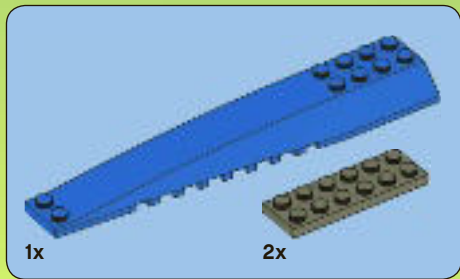

5

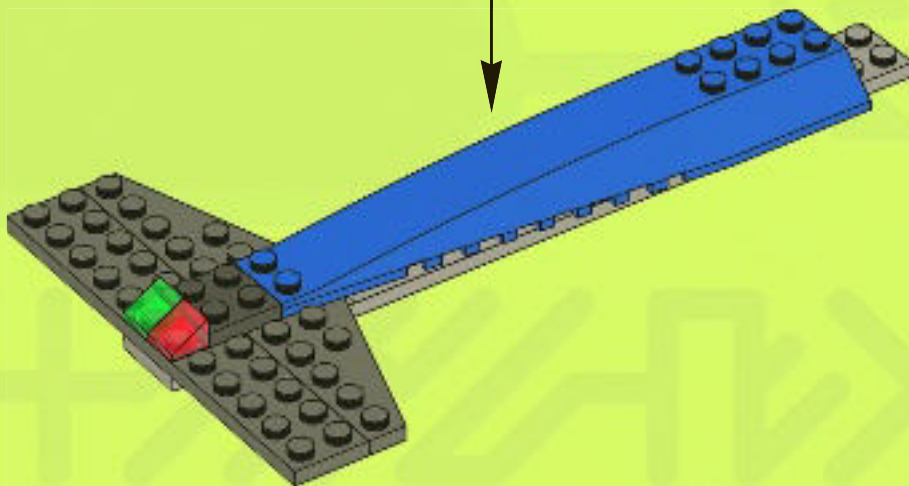
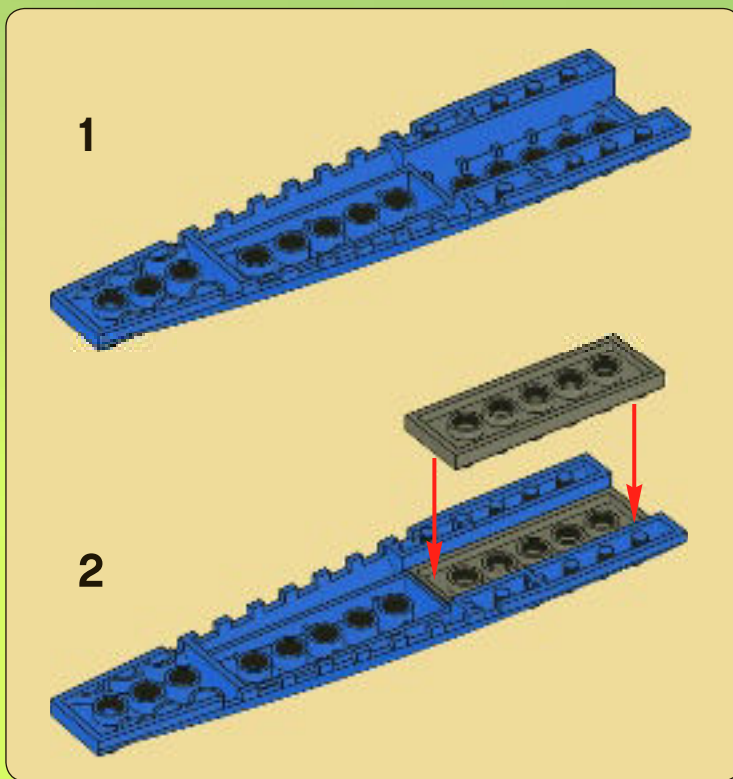



6

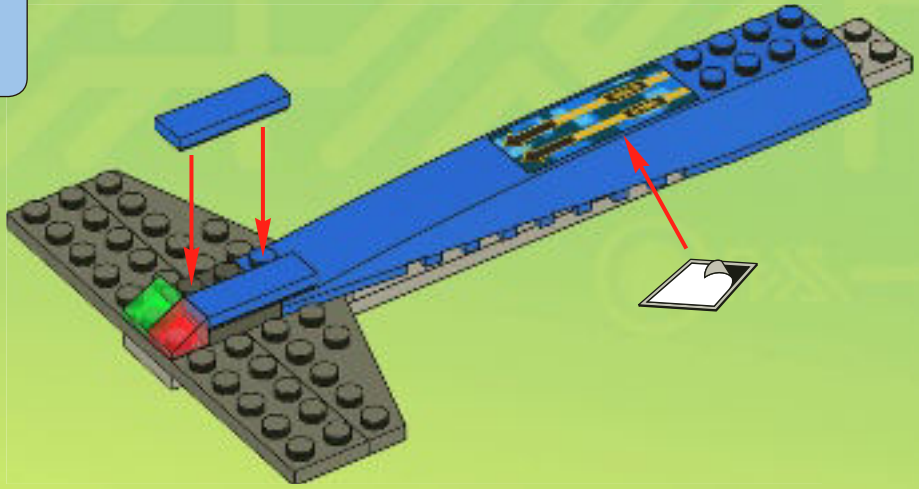

25

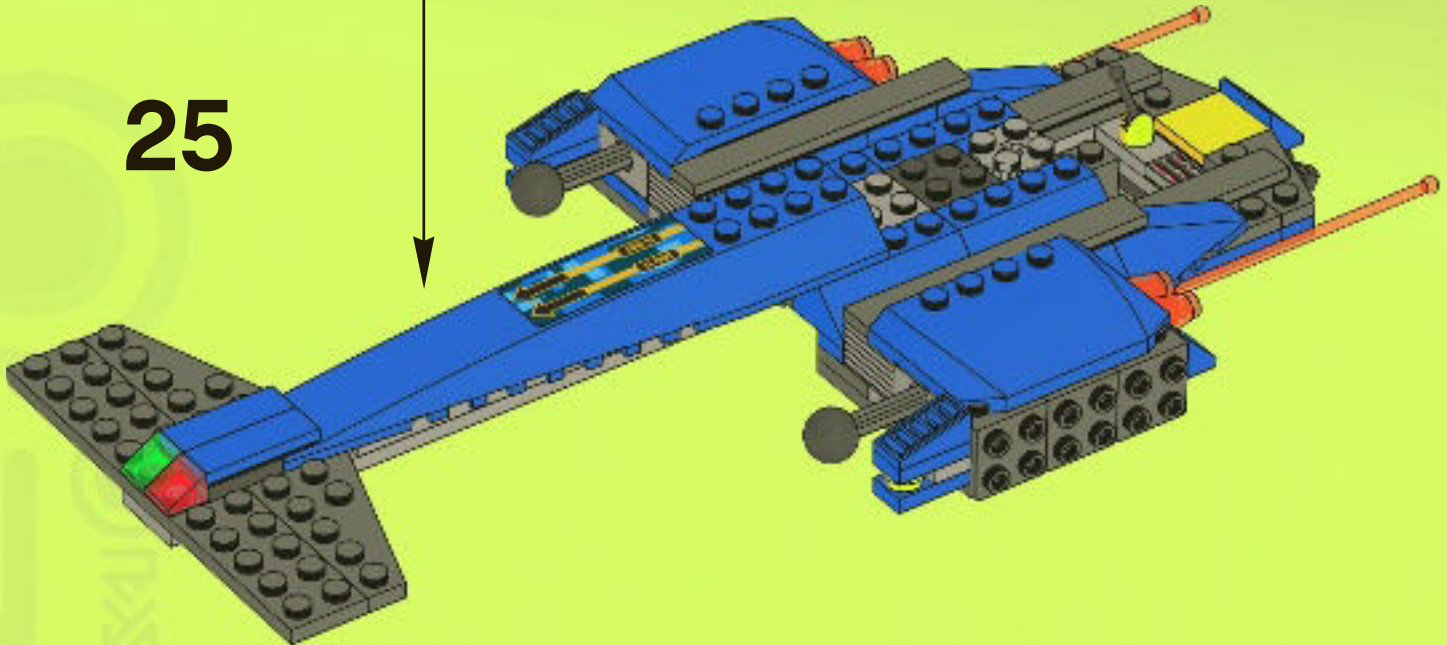



26

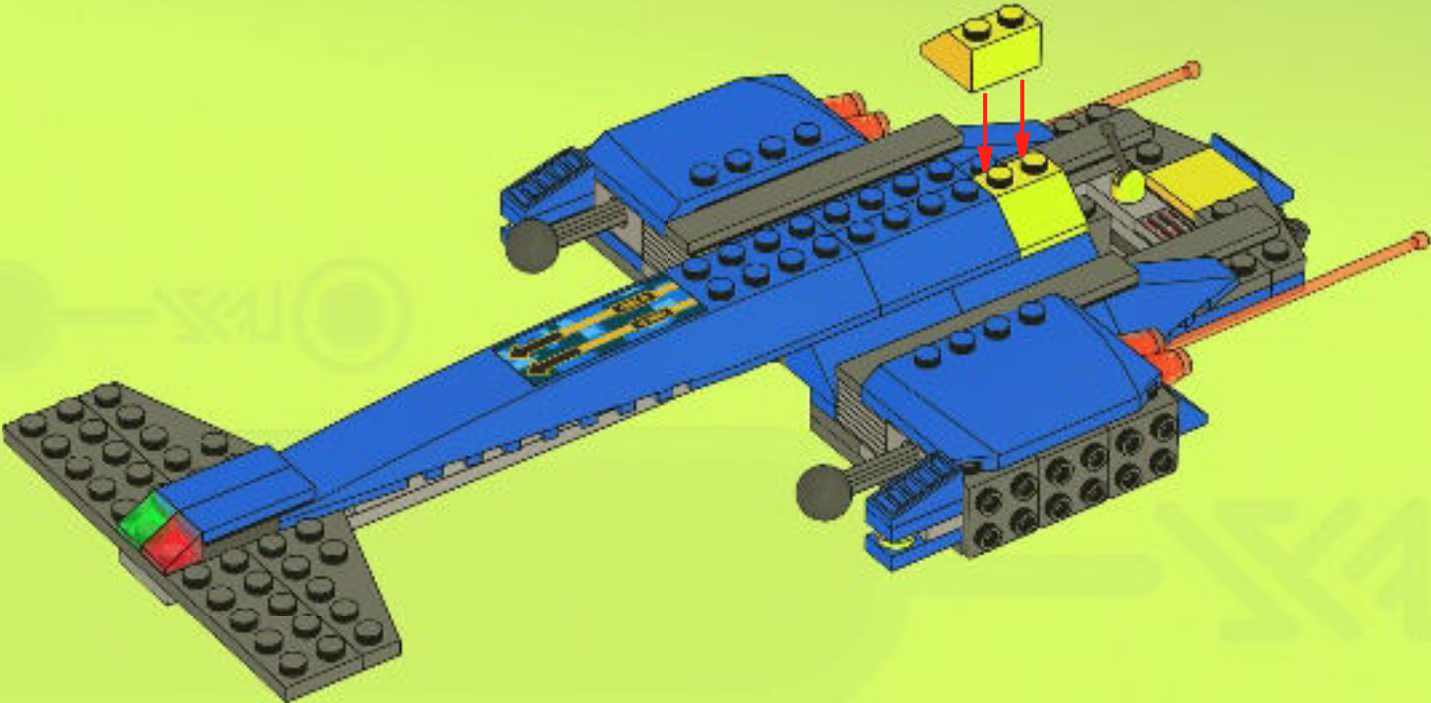



27

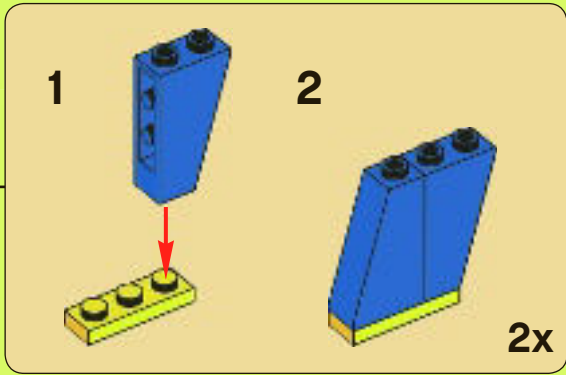
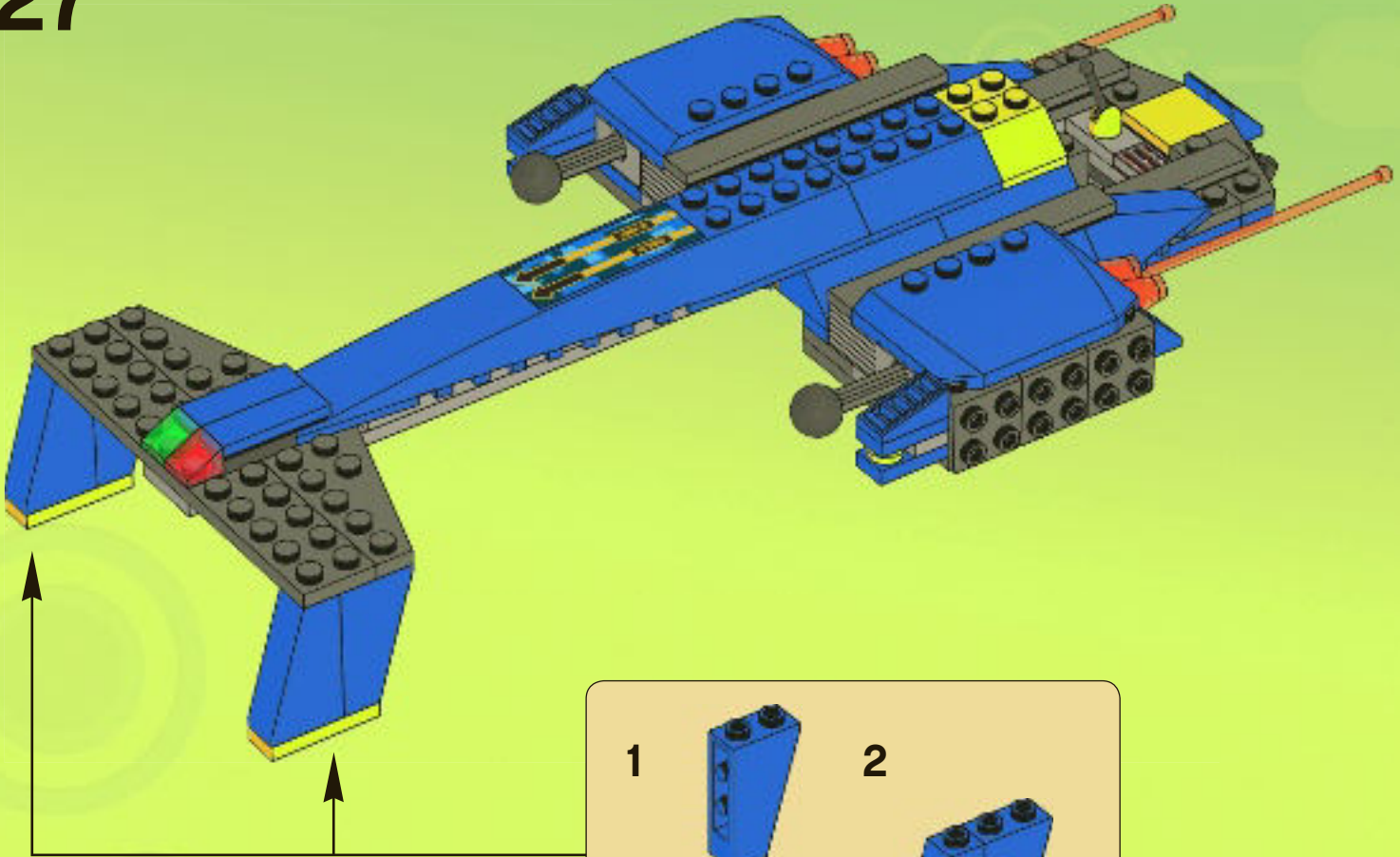



2x



2x

28

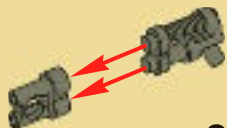

2x

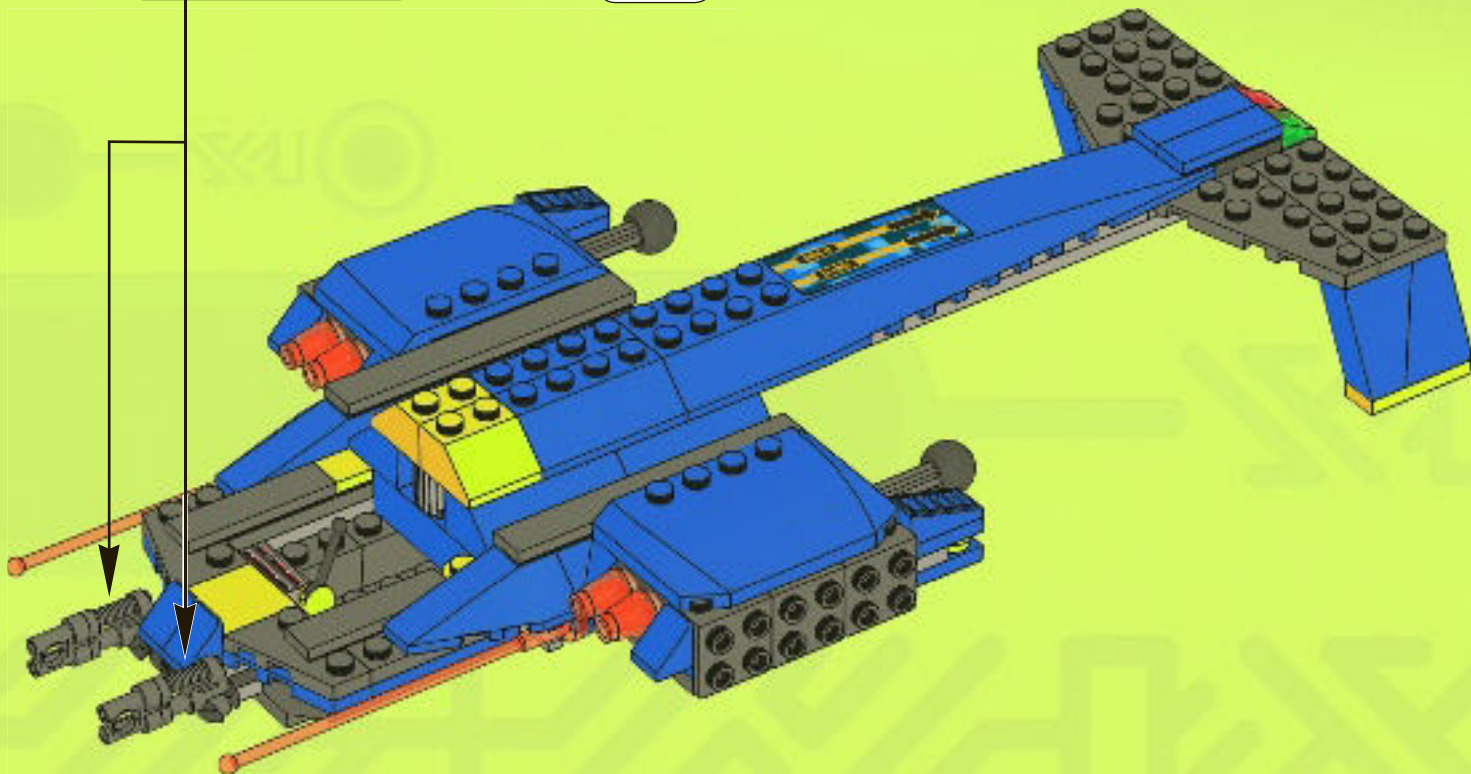

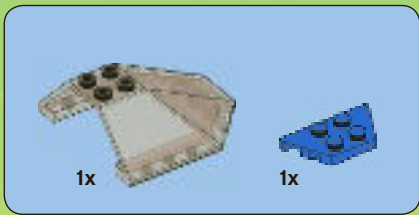

29

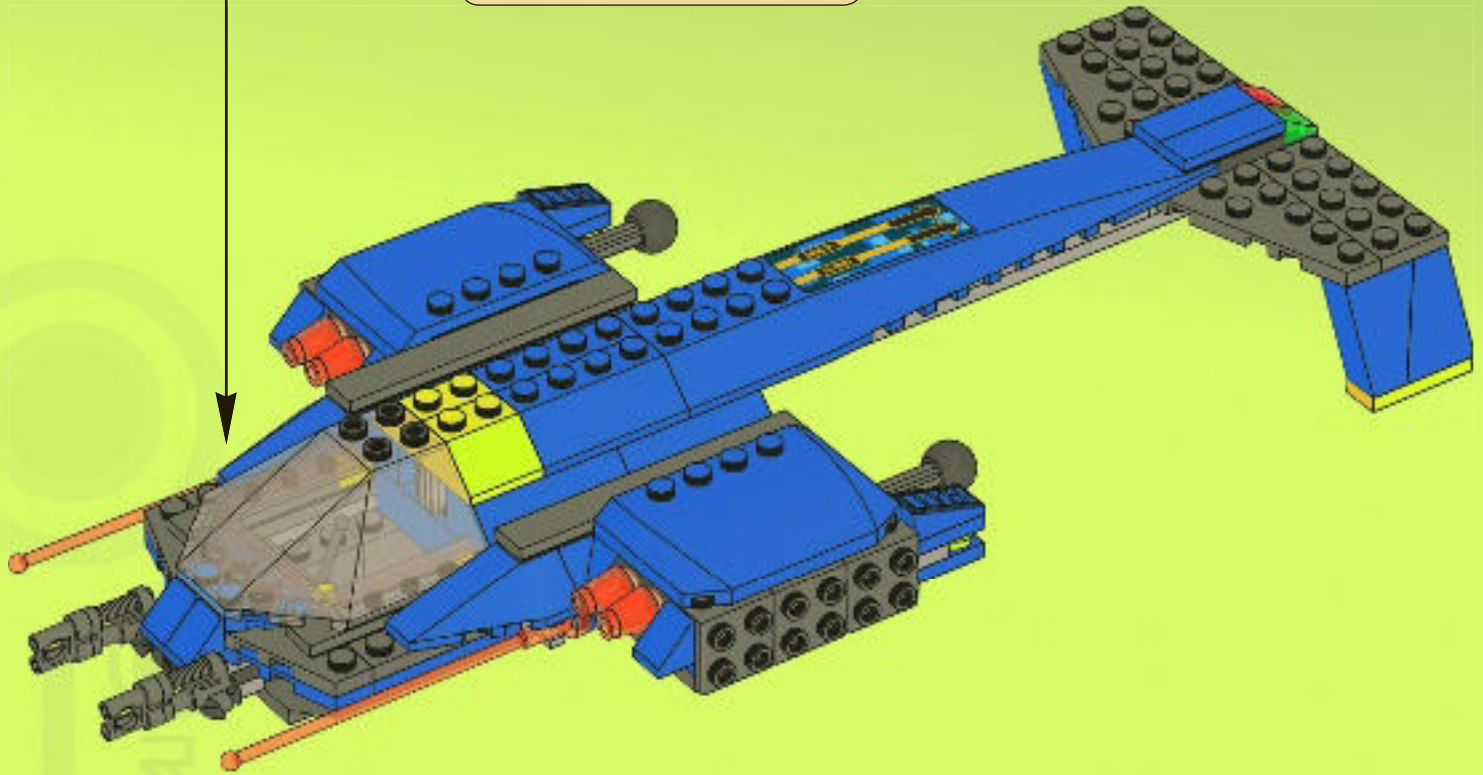
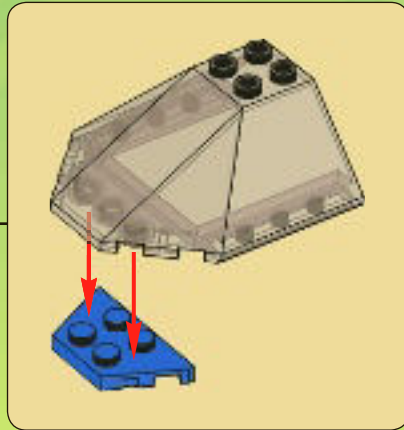



30

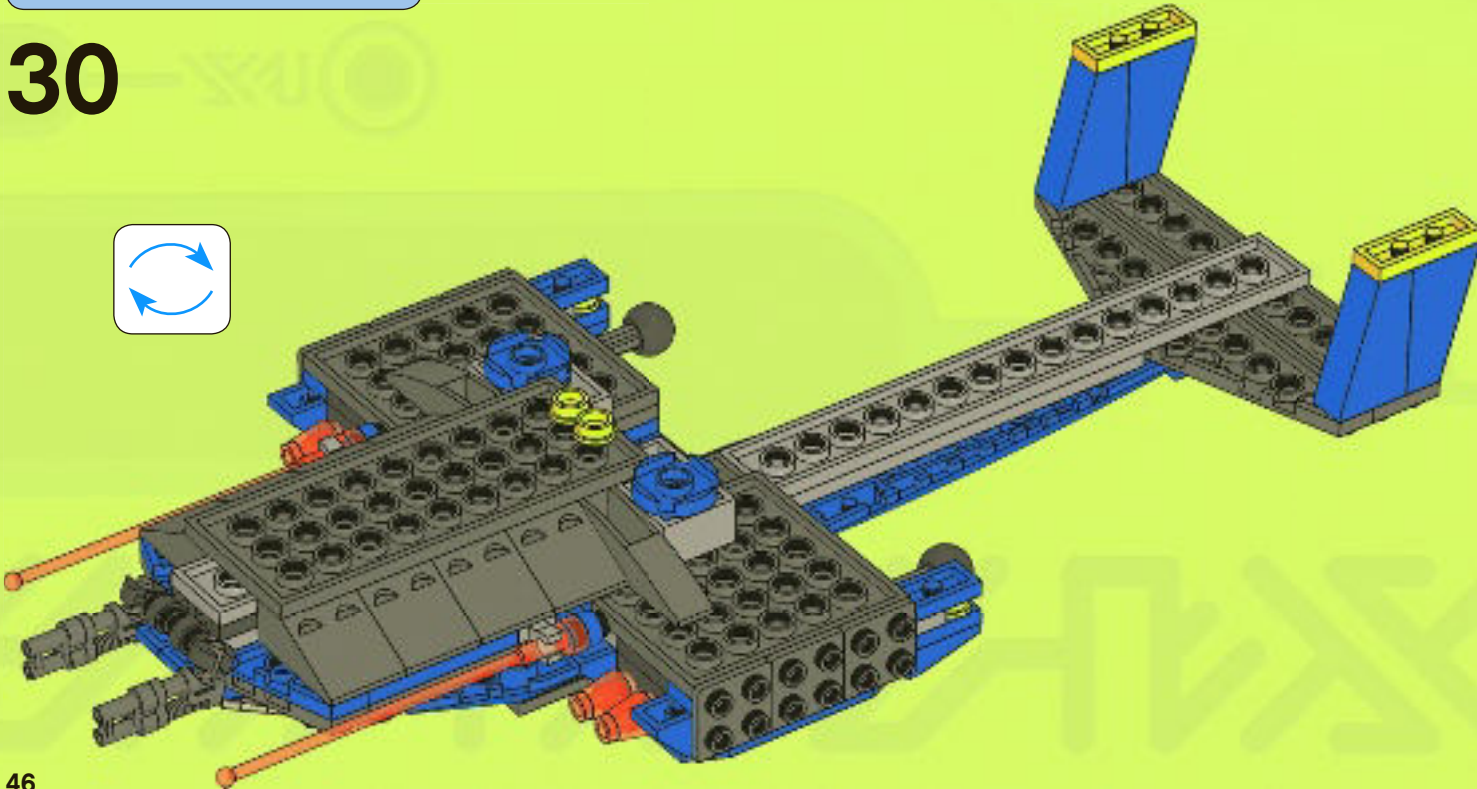

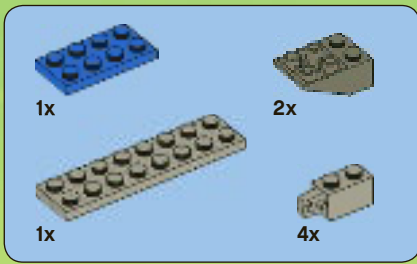

31

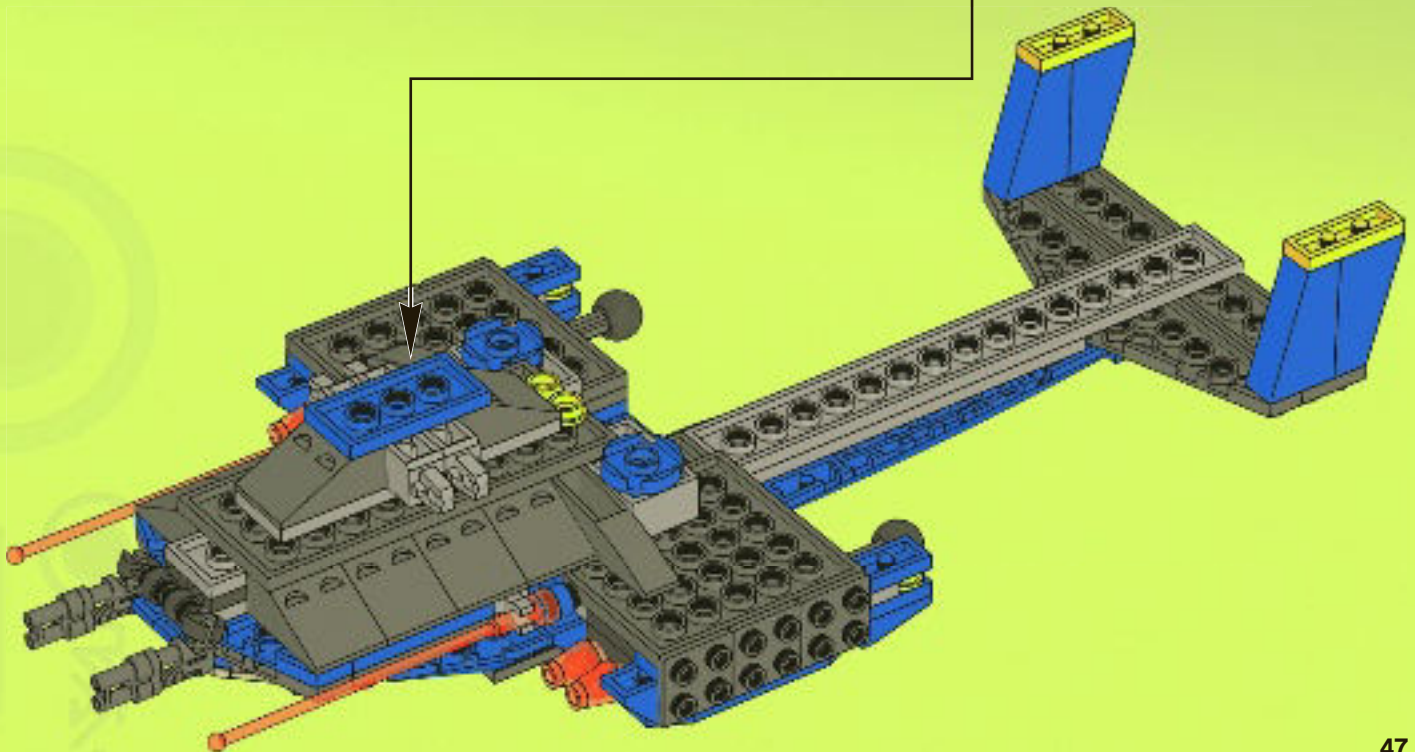
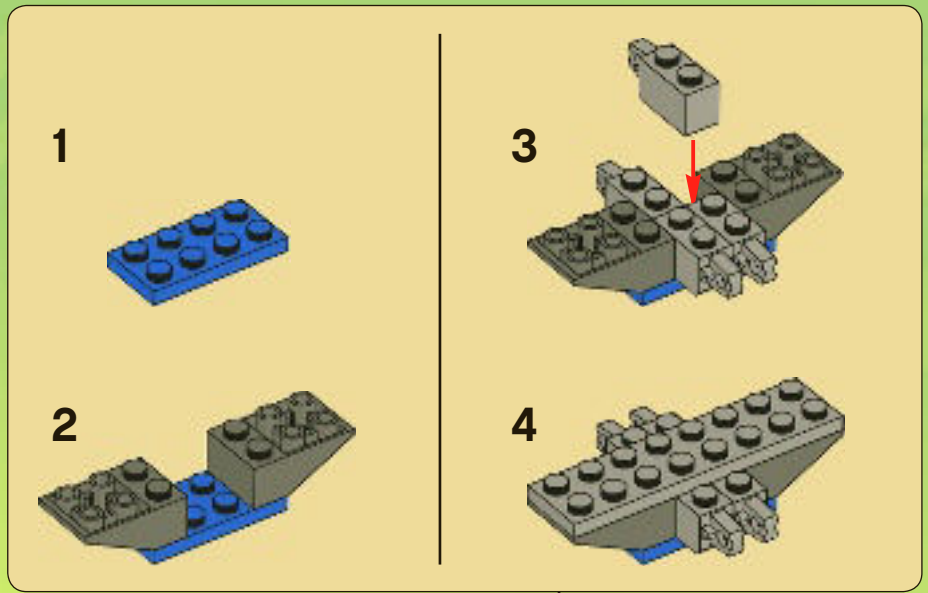

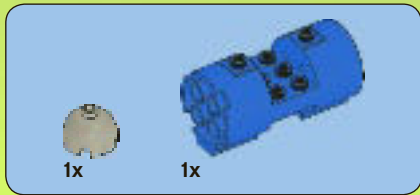
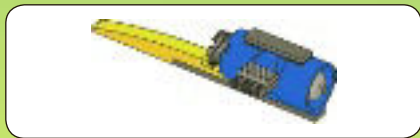

1

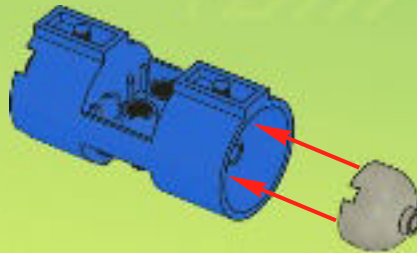

2

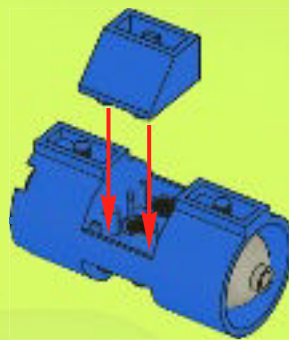

3

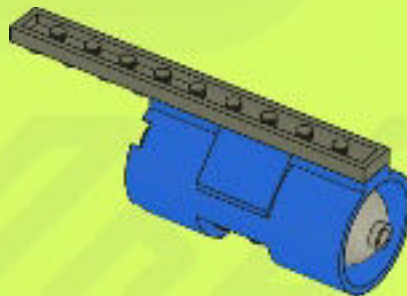



4

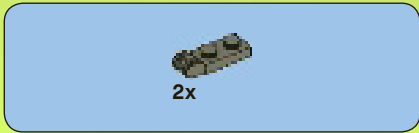
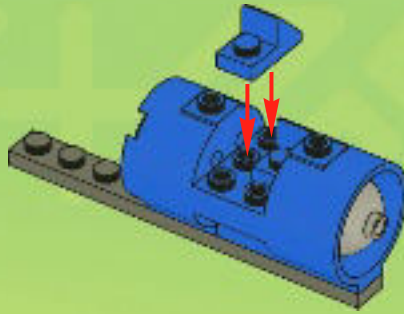

5

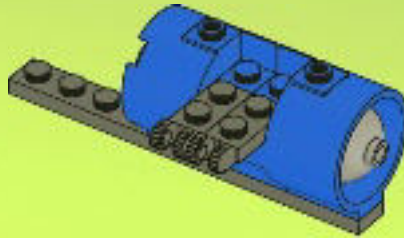

6

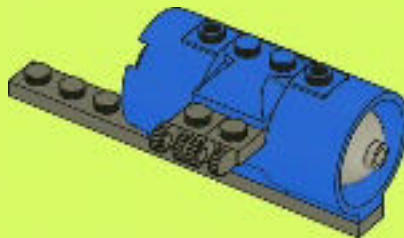



7

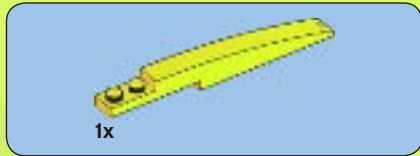
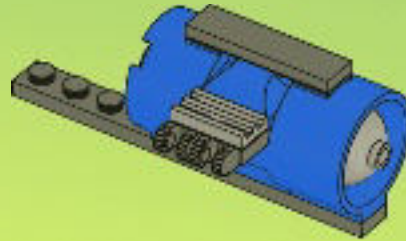

8

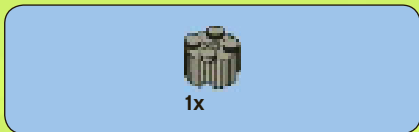
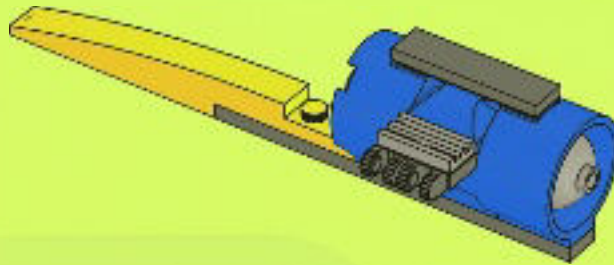

9

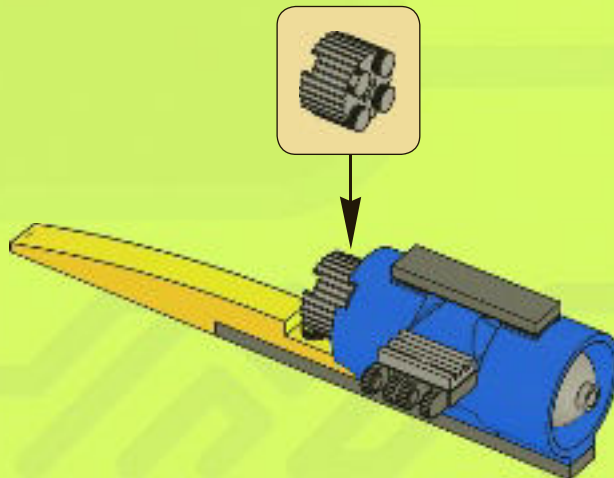

32

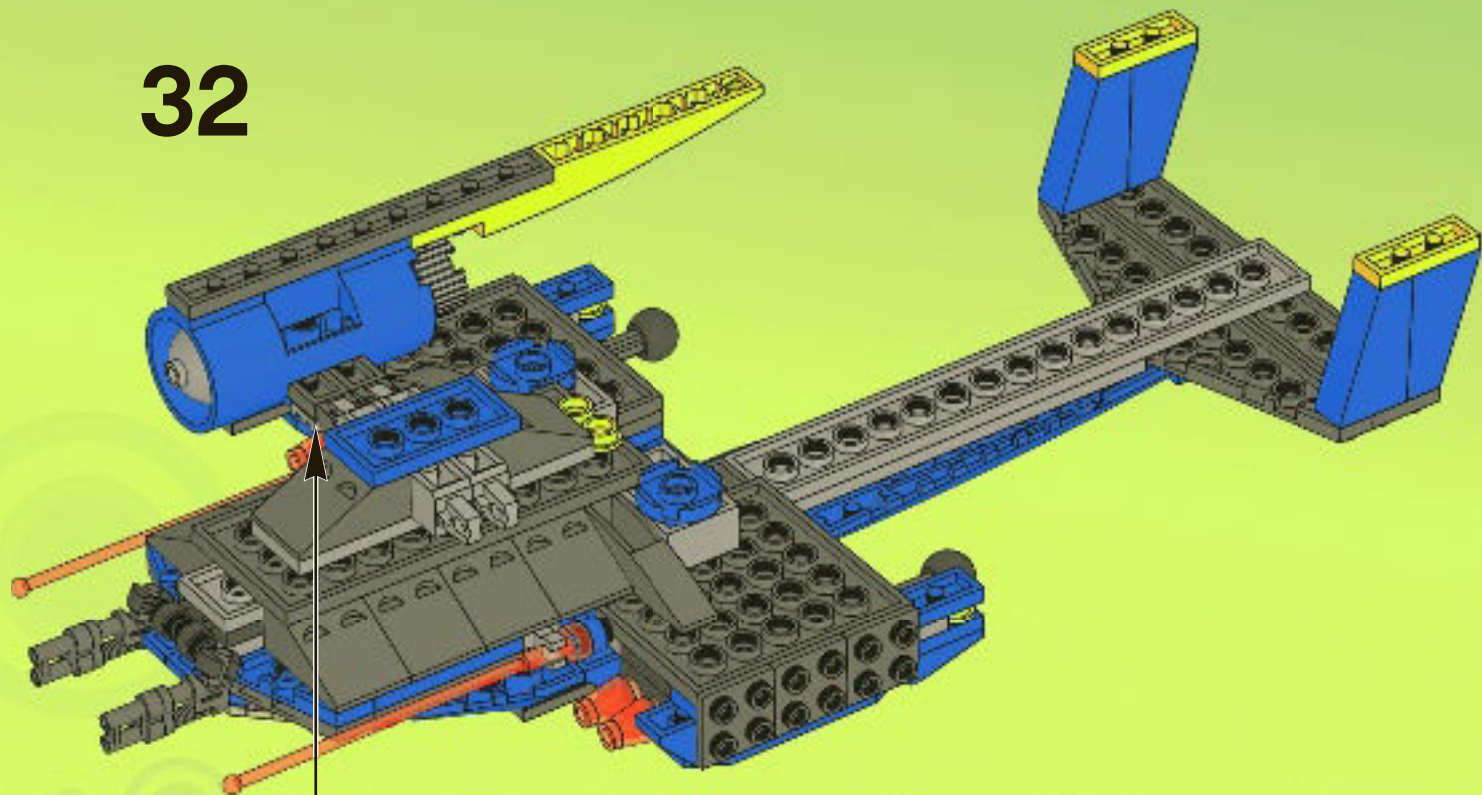

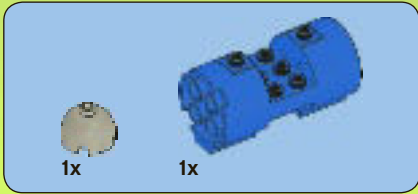
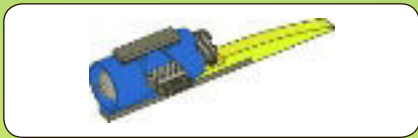

1

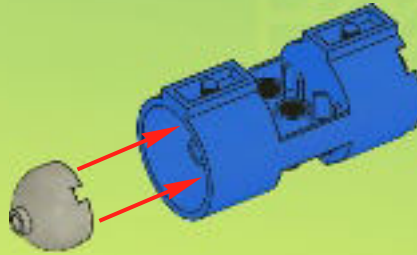

2

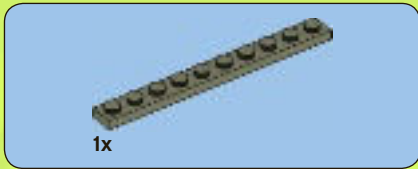
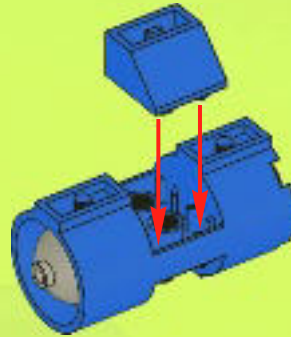

3

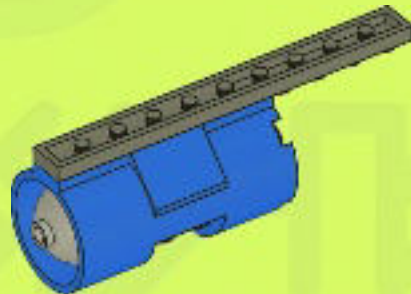



4

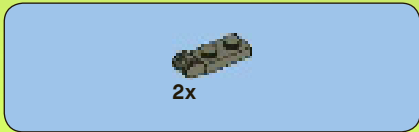
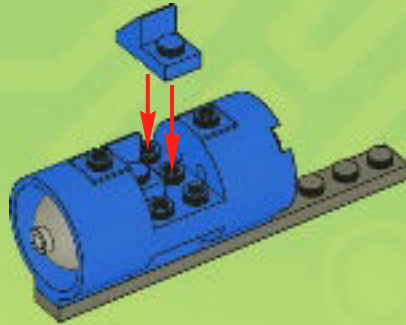

5

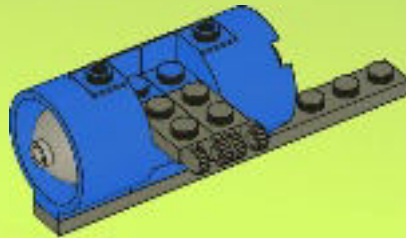

6

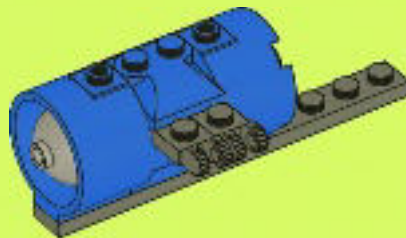

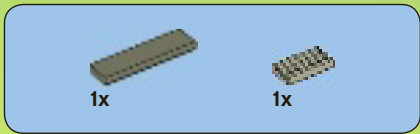

7

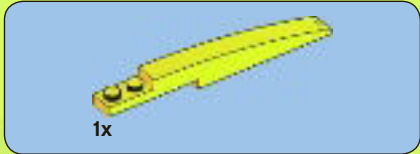
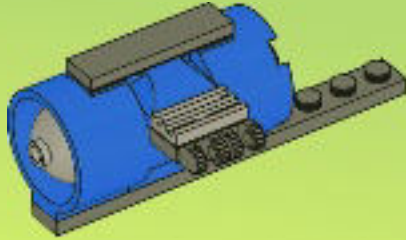

8

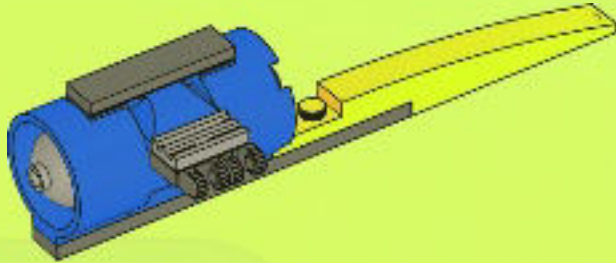

9

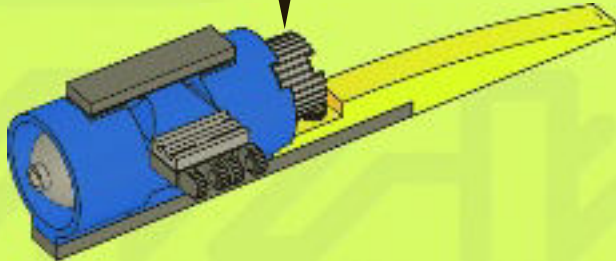

33

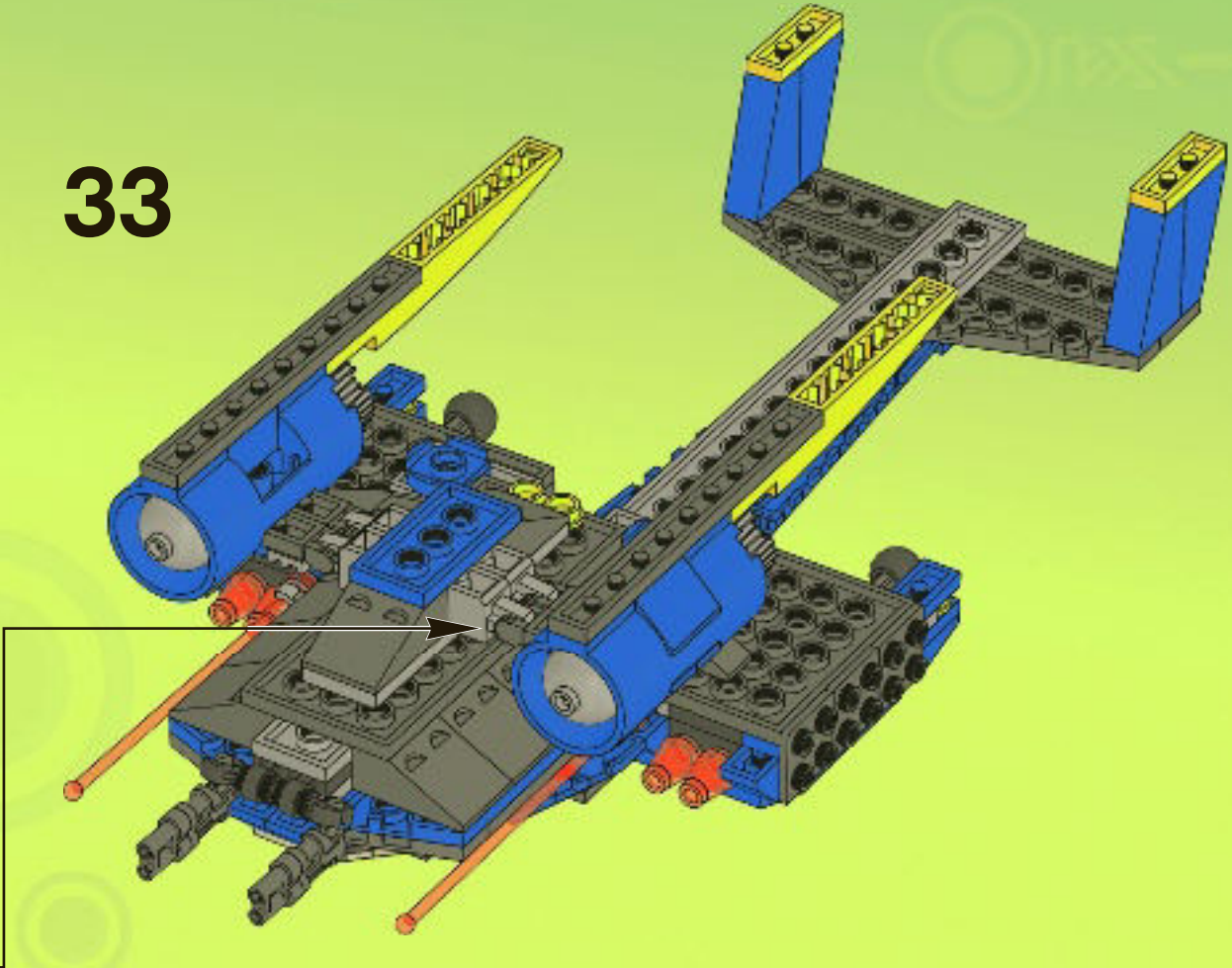

34

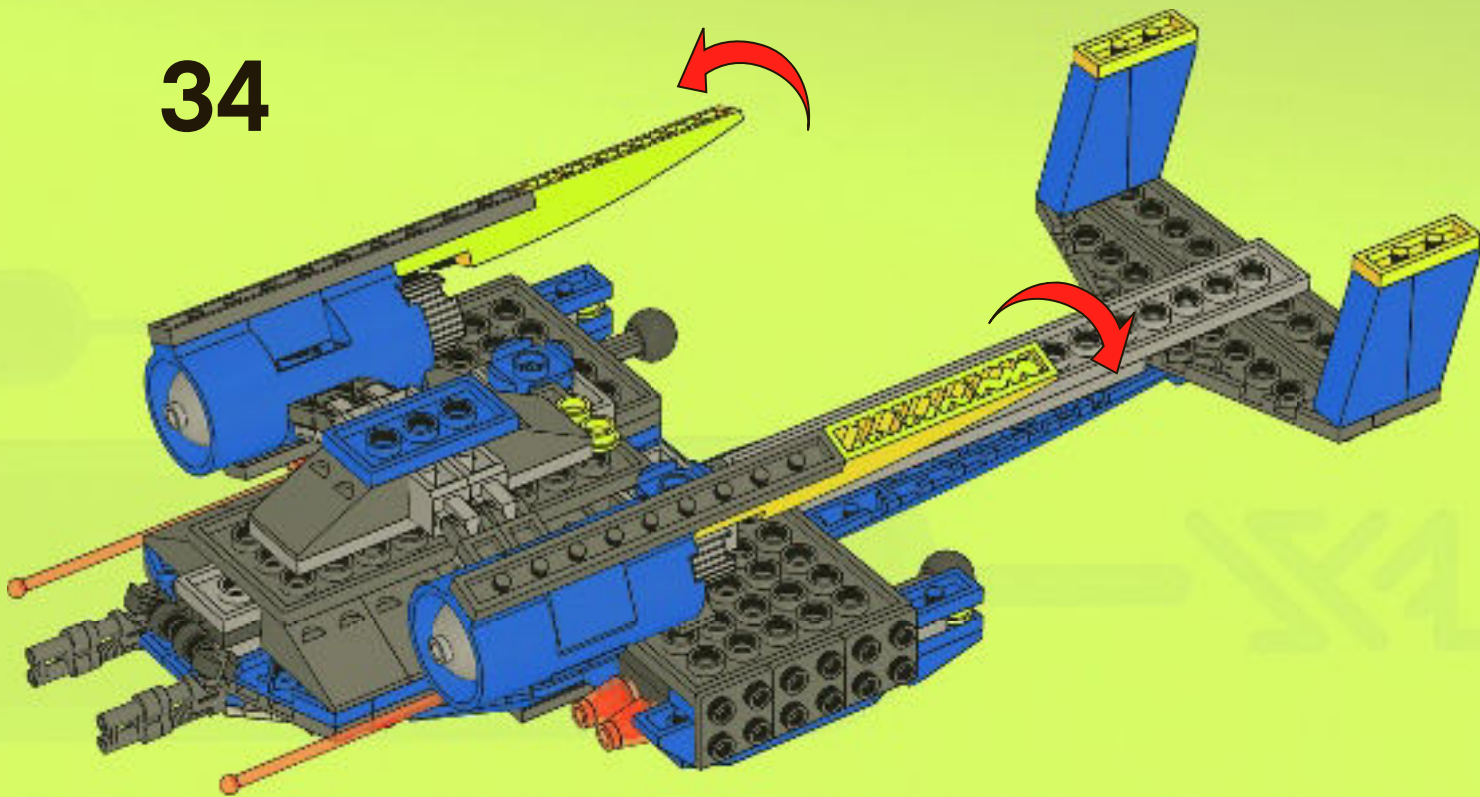



1



2

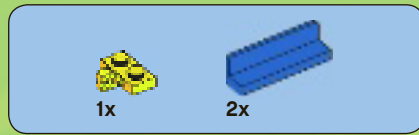
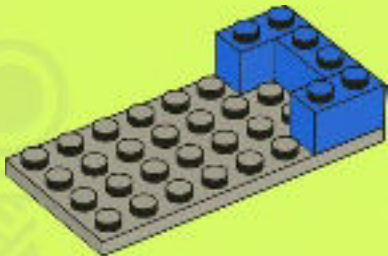

3

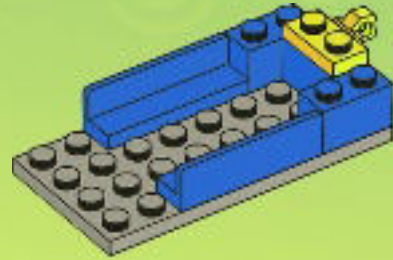

4

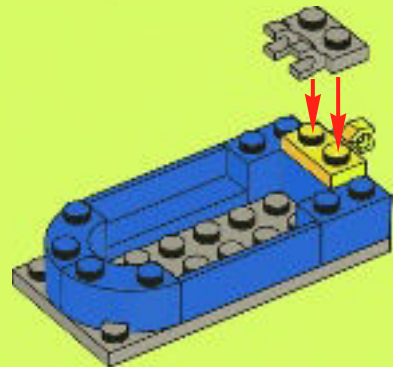



2x

5

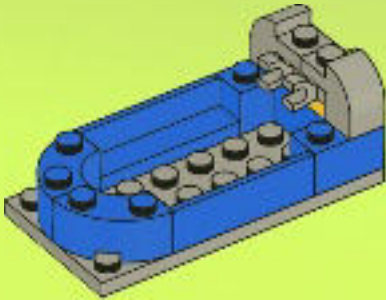

1x

7

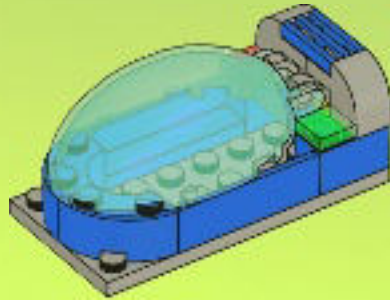

1x



1x



1x

6

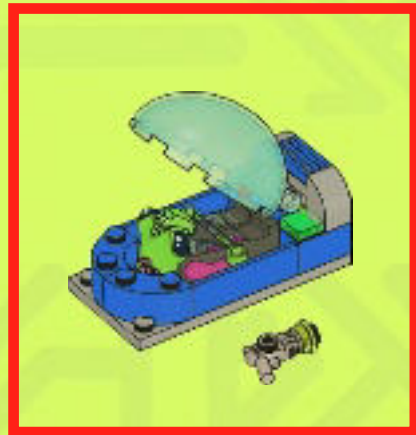
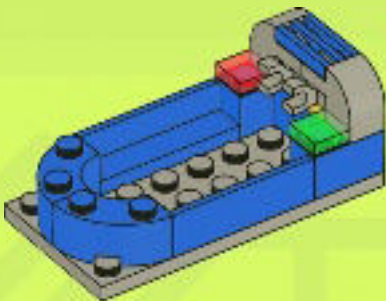

8

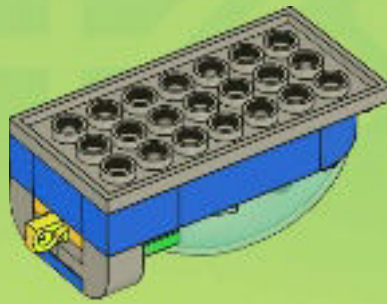

35

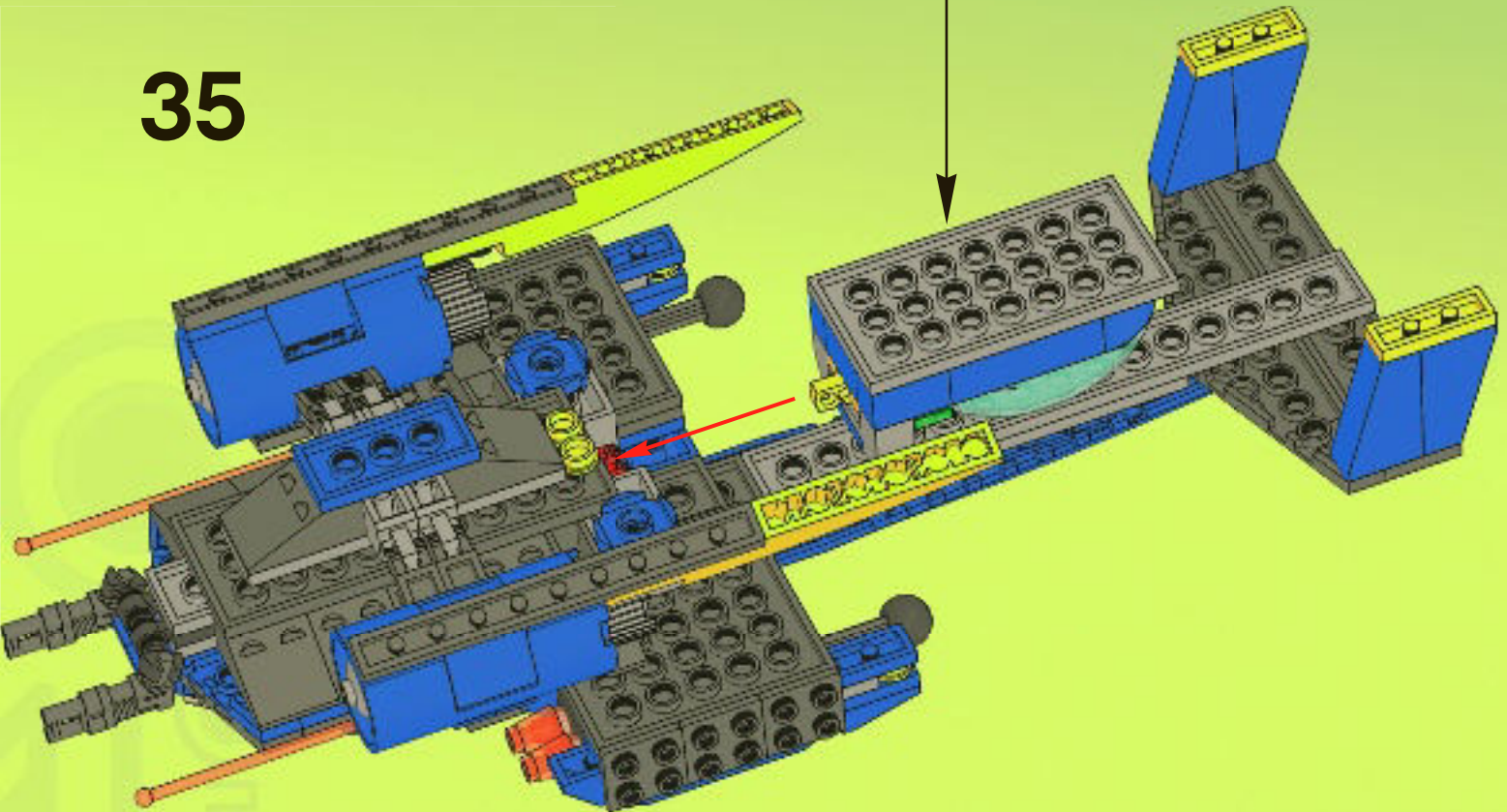



1x

36

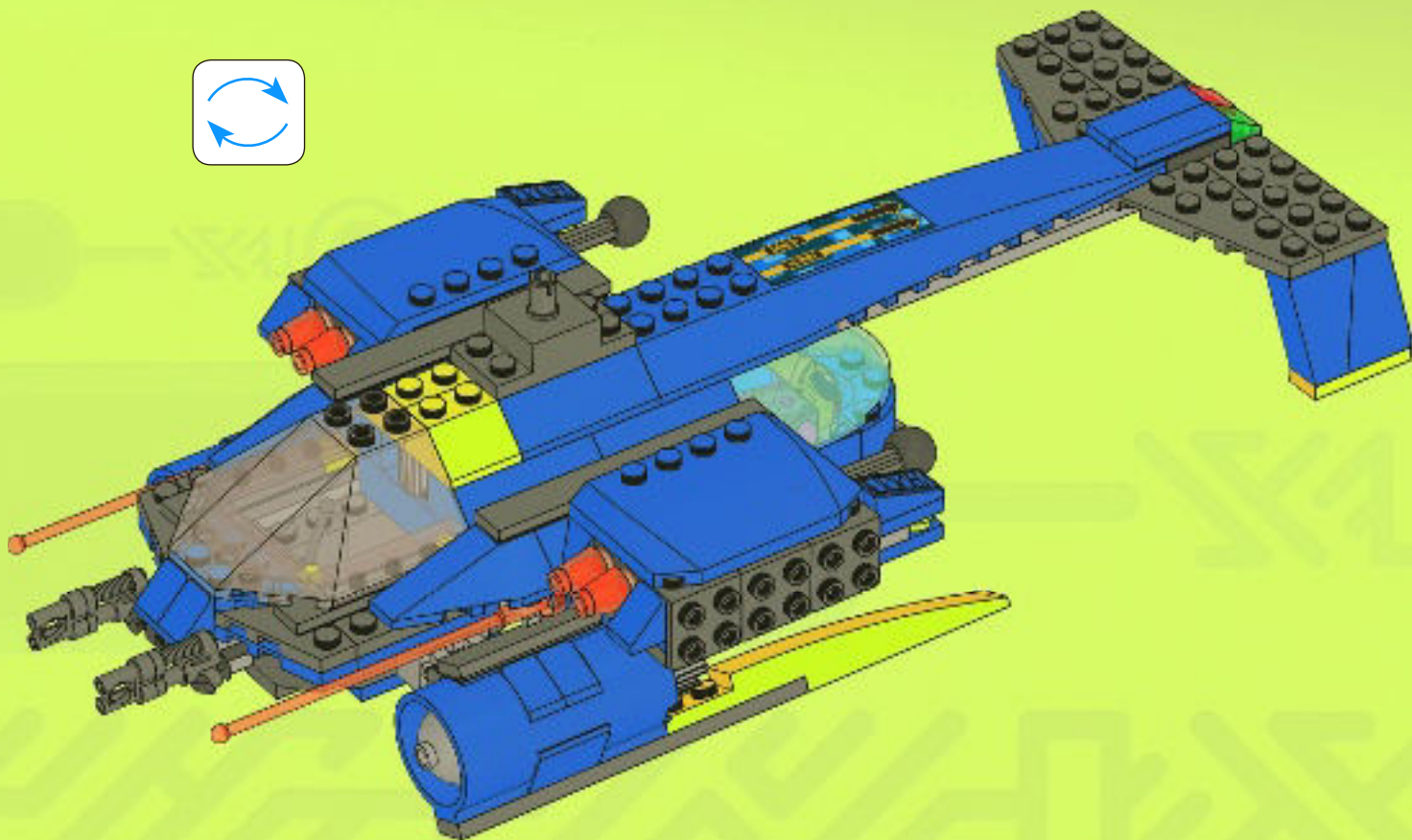



4x



1x

37

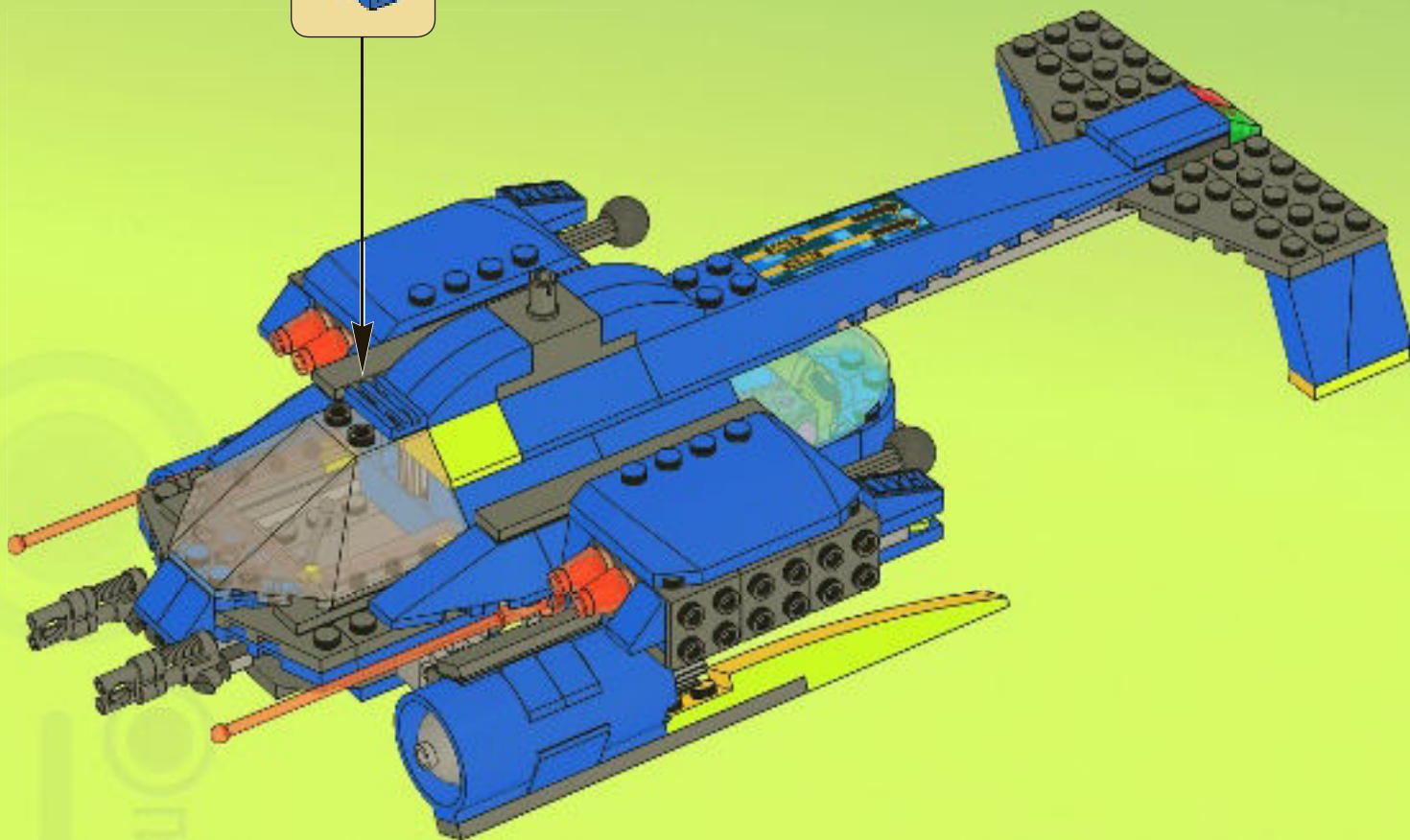

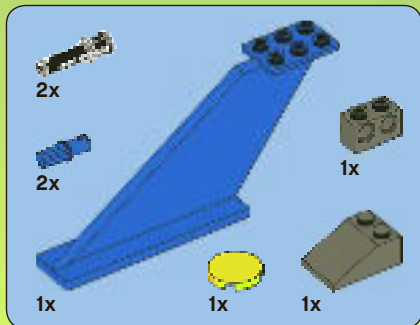

38

1

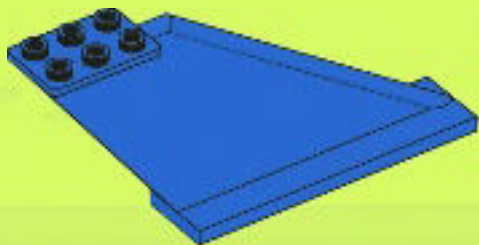

2



3

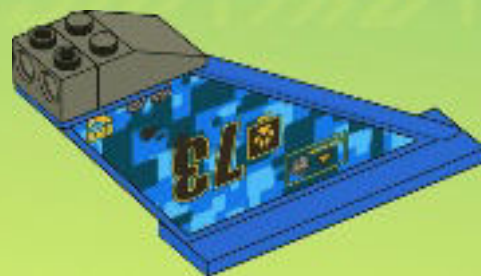

4



5

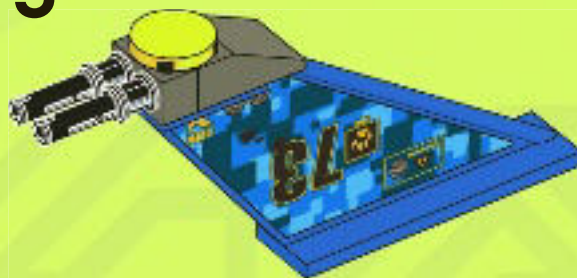

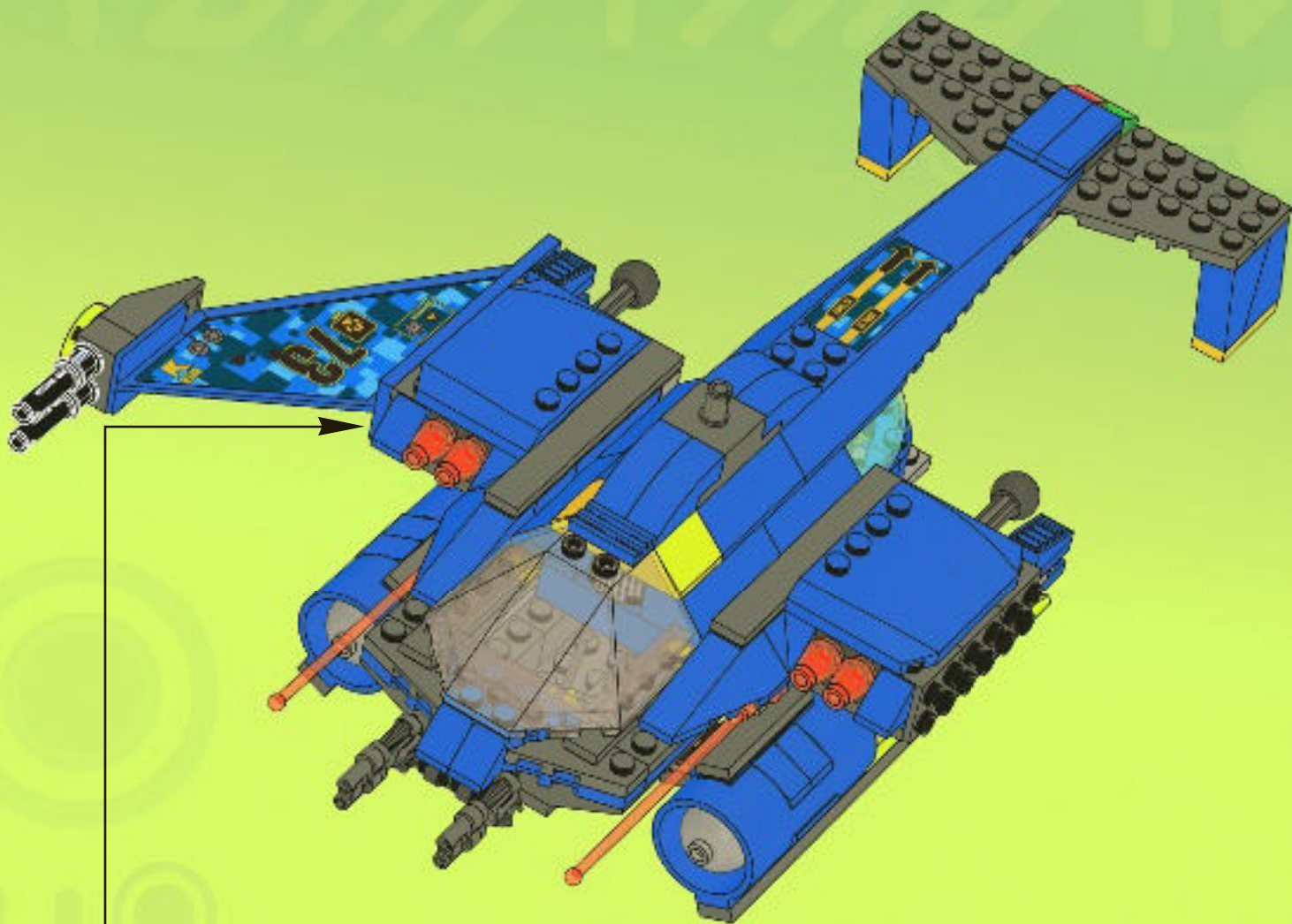

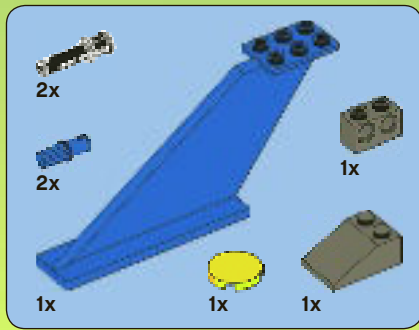

39

1

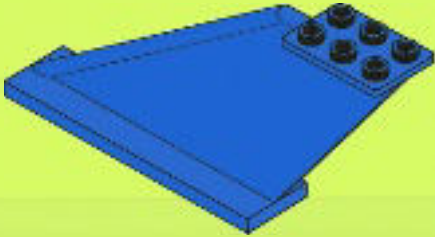

2



3

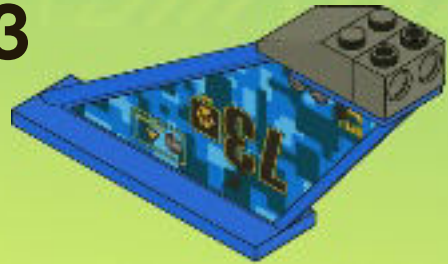

4

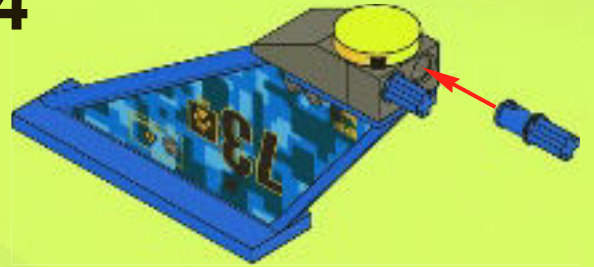

5

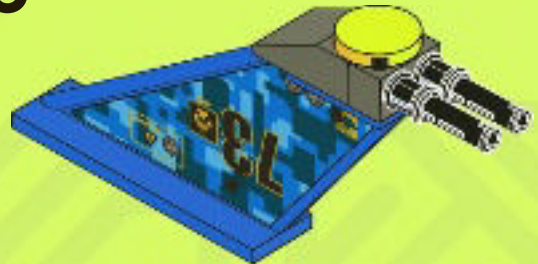

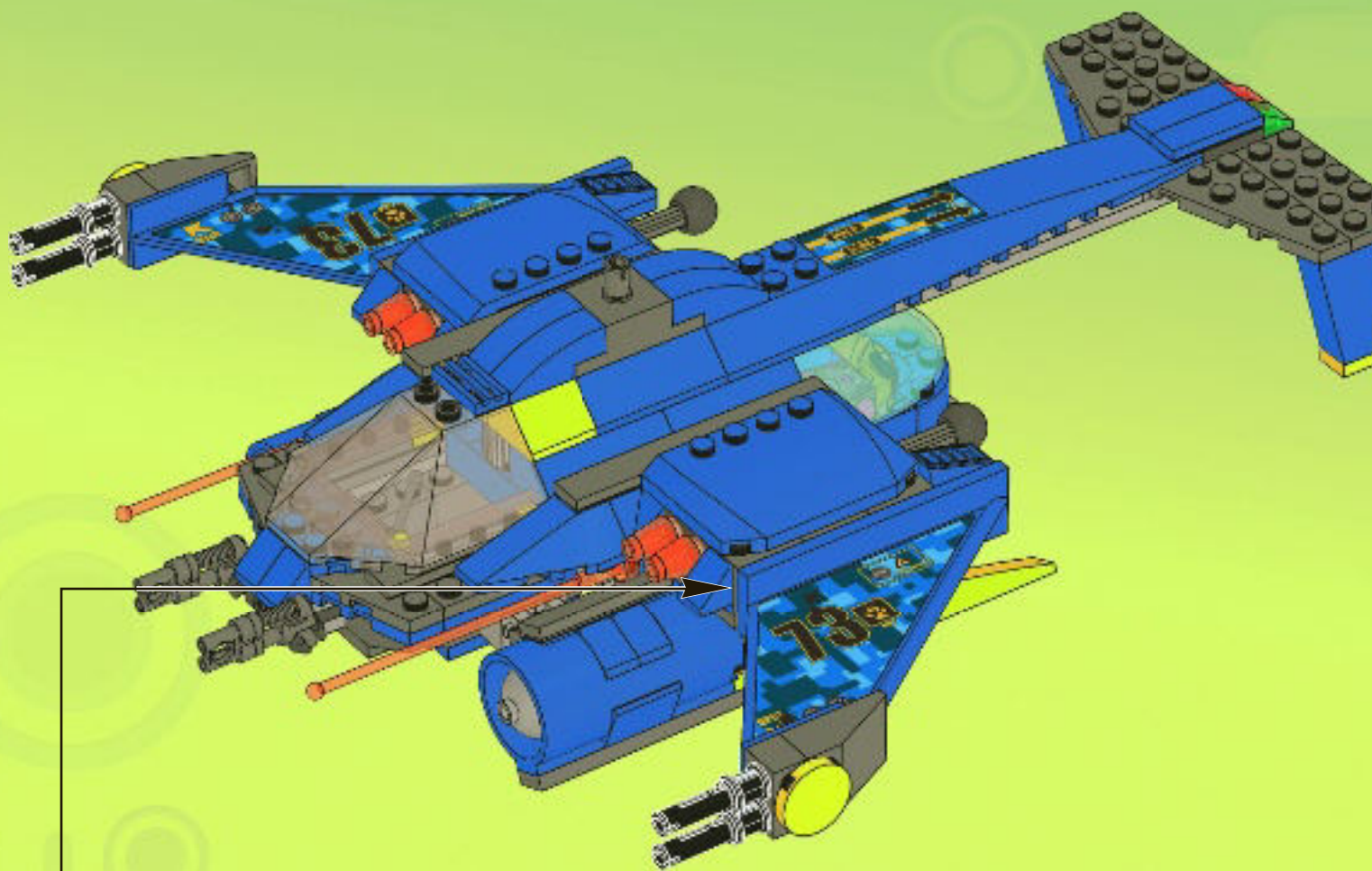

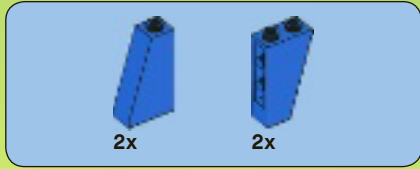

40





2x

41



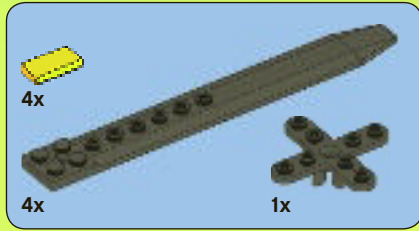
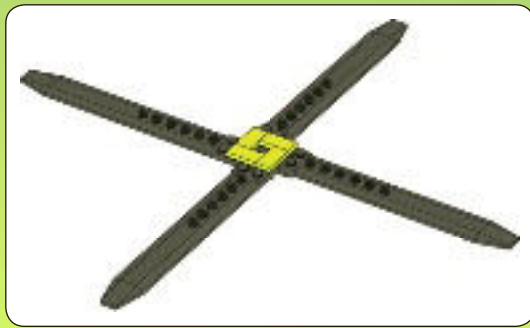

42

1

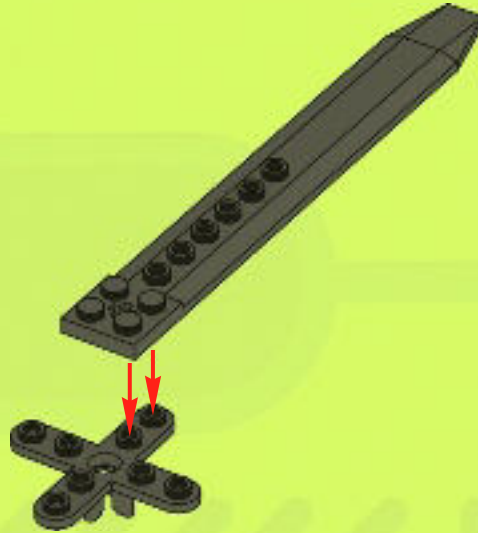

2





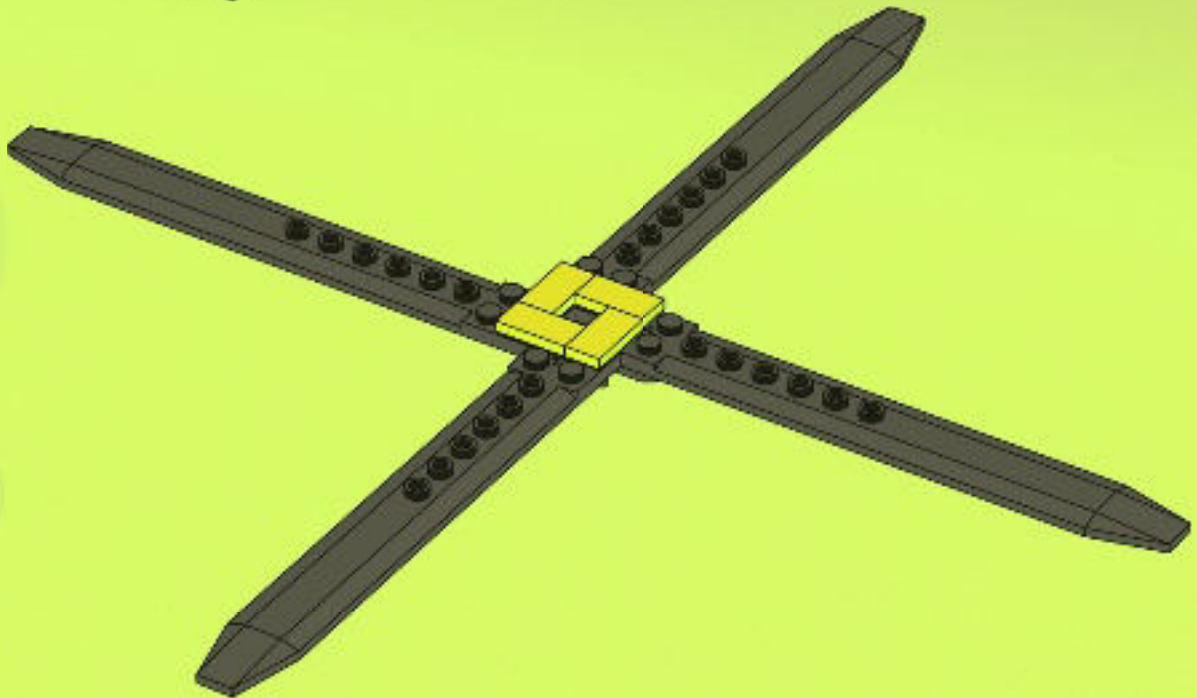

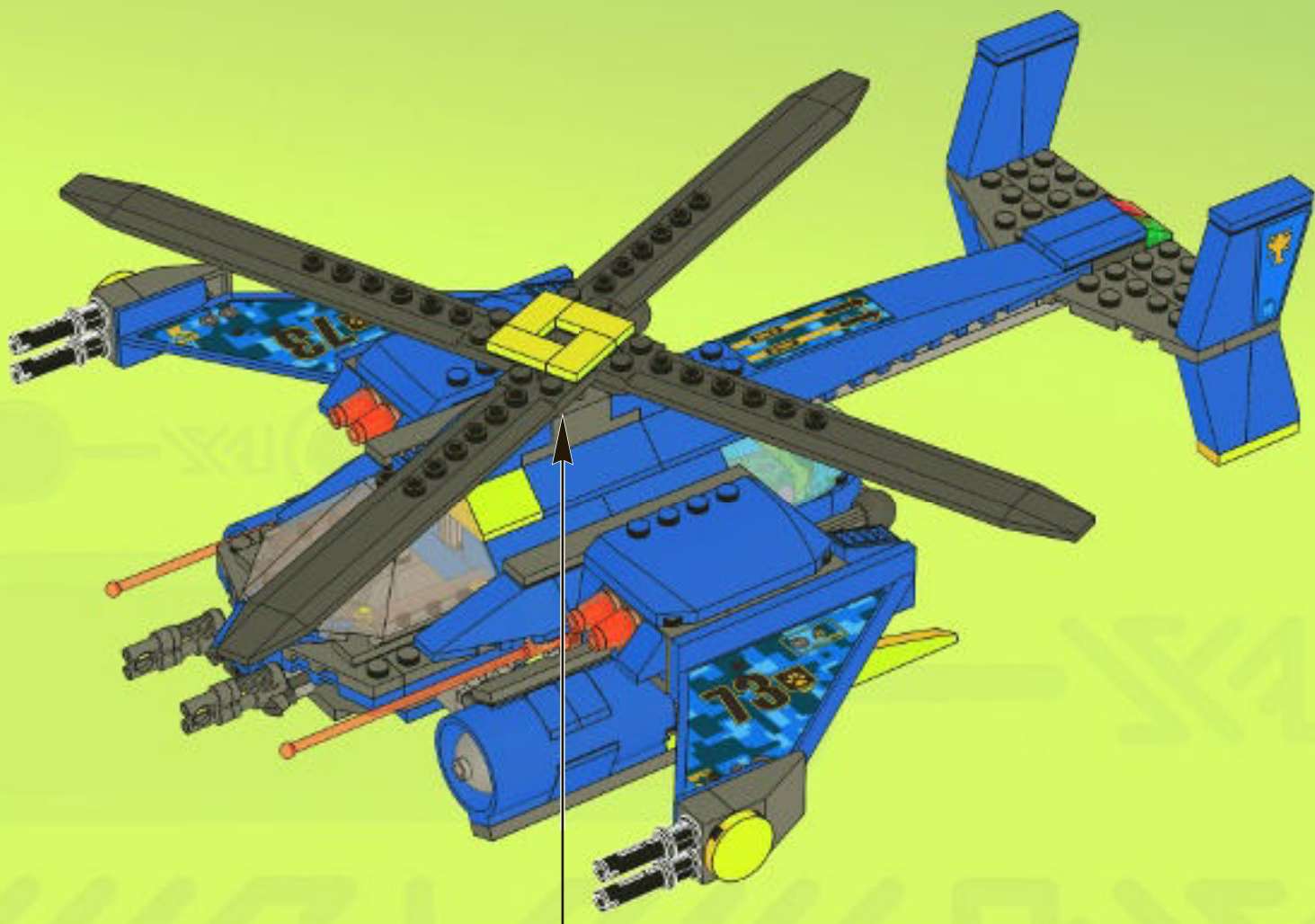







































































3







 3x 300423	 1x 4622179	 2x 403223	 1x 4185617	 2x 4289538	 2x 3005749
 5x 300123	 1x 4622180	 1x 4609454	 5x 614124	 2x 4290713	 2x 3006349
 2x 4586955	 4x 4543998	 2x 4522164	 2x 415024	 1x 4121715	 2x 4567334
 2x 4632567	 6x 302323	 5x 4206482	 1x 74156	 4x 4140801	 2x 4220631
 2x 241223	 4x 4587840	 2x 4496366	 1x 4625824	 1x 4626724	 4x 4540385
 2x 4597338	 2x 371023	 1x 4498156	 2x 3200026	 2x 4613756	 4x 4537937
 8x 4620297	 1x 302023	 1x 4498155	 5x 302226	 1x 4244363	 4x 4537937
 4x 4498154	 6x 346023	 2x 303924	 8x 371026	 1x 3003941	 2x 4624402
 4x 4121925	 2x 4294739	 2x 4551620	 2x 4632571	 4x 4586557	 4x 4567331
 2x 4626370	 2x 4645090	 3x 307024	 4x 4598528	 1x 4571078	 1x 4244573
 2x 366023	 2x 4565427	 4x 306924	 4x 4527604	 4x 4624375	 1x 4216384
 6x 4107437	 1x 4636725	 1x 306824	 2x 4623649	 2x 4621915	 2x 4565452
		 2x 362324	 2x 4623504	 1x 4580739	 1x 4515338
			 1x 247926		



2x
4211519



8x
4532593



1x
4212363



2x
4211396



6x
4211438



3x
4211406



1x
4211407



2x
4211486



2x
4541978



2x
4211350



1x
4211451



1x
4556157



2x
4282740



2x
4625001



8x
4211469



8x
4211470



4x
4520320



2x
4211386



2x
4211383



4x
4211693



3x
4650645



2x
4211637



2x
4211440



4x
4521921



8x
4211614



1x
4239373



8x
4210639



2x
4210762



2x
4211106



10x
4211064



4x
4211076



4x
4620760



2x
4210779



2x
4508553



4x
4211063



4x
4211053



4x
4211002



2x
4211008



2x
4211134



2x
4257526



1x
4211122



3x
4211067



6x
4277928



4x
4210884



1x
4210872



1x
4210869



1x
4290149



1x
4290150



2x
4211051



2x
4623236



16x
4566522



1x
4629691



1x
4636718



1x
4626452



2x
4625812



Customer Service

Kundenservice

Service Consommateurs

Servicio Al Consumidor

www.lego.com/service or dial



: 00800 5346 5555

: 1-800-422-5346



ALIEN CONQUEST



ALIENCONQUEST.LEGO.COM



www.LEGOclub.com



LEGO® Club Email

LEGO club™

FREE! GRATIS! GRATUIT!



LEGO® Club Magazine

SIGN UP ONLINE!

www.LEGOclub.com



00800 5346 5555*



1-866-534-6258 • 1-877-518-5346

US & Canada only

Canada seulement

* Freephone. Mobile charges may apply.
* Numéro sans frais. Des frais peuvent s'appliquer avec les téléphones cellulaires.
* Gebührenfrei, Kosten für Anrufe aus Mobilfunknetzen können abweichen.
* Gratis telefonnummer vanaf vaste lijn.
* Det är et gratis nummer, når du ringer fra fasttelefon.
* Det är gratis, när du ringer från en fast telefon.
* Numéro sans frais. Des frais peuvent s'appliquer avec les téléphones portables.



WIN!

Go to www.LEGOsurvey.com/product to fill out a survey for a chance to win a cool LEGO® Product. No purchase necessary. Open to all residents where not prohibited.

 www.LEGO.com



www.LEGOsurvey.com/product

GEWINNE! WIN!

Nimm an der Umfrage auf www.LEGOsurvey.com/product teil und hab die Chance ein cooles LEGO® Produkt zu gewinnen!
Die Teilnahme am Gewinnspiel führt zu keinerlei Kaufverpflichtungen. Teilnahme in allen nicht ausgeschlossenen Ländern möglich.

Ga naar www.LEGOsurvey.com/product, vul een enquêteformulier in en maak kans op een cool LEGO® product.
Geen aankoopverplichting. Iedereen mag deelnemen, uitgezonderd ingezetenden van landen waar een enquêteverbod geldt.

GAGNE! 当てよう!

Visite www.LEGOsurvey.com/product pour répondre à un questionnaire et avoir une chance de gagner un produit LEGO® très cool!
Aucune obligation d'achat. Ouvert à tous les résidents des pays autorisés.

www.LEGOsurvey.com/product にアクセスして、アンケートにご記入ください。当選者にはレゴ®製品を差し上げます。
お買い上げの必要はありません。
禁止されていない限り、すべての皆様にご利用いただけます。